



FENCE ENERGIZER **iSERIES**

PUBLISHED BY
Gallagher Group Limited
181 Kahikatea Drive, Private Bag 3026
Hamilton, New Zealand

www.gallagher.com
Copyright© Gallagher Group Limited 2020
All rights reserved. Patents pending.

Gallagher i-Series Energizer User Manual

3E3618 - Edition 9 - August 2020

DISCLAIMER: Whilst every effort has been made to ensure accuracy, neither Gallagher Group Limited nor any employee of the company shall be liable on any ground whatsoever to any party in respect of decisions or actions they may make as a result of using this information. In accordance with the Gallagher policy of continuing development, design and specifications are subject to change without notice. Developed and manufactured by Gallagher Group Limited, and ISO 9001 2000 Certified Supplier.

Contents

3E3446 M5800i M10000i Energizer User Manual

Important Information.....	5
How the Energizer works	7
Installation Guide.....	8
Understanding Your Energizer	11
Understanding Your Energizer Controller	12
Accessories	18
Troubleshooting.....	19
Waste Electrical And Electronic Equipment.....	19

3E2749 Remote & Fault Finder User Manual

Remote Readings.....	23
Installing the battery.....	24
Features	24
Checking your fence and finding faults.....	25
Detecting Alarms	26
Turning the Energizer On / Off (Standby)	26
Using your Remote with multiple Energizers.....	27
Understanding your Electric Fence	29

3E2748 Fence Monitor User Manual

Introduction.....	33
Installation	34
Using your Fence Monitor	37
Choosing an Installation Location.....	39
Troubleshooting.....	42

SMS Energizer Controller User Manual

Understanding your SMS Energizer Controller	45
Understanding SMS messages.....	47
Troubleshooting.....	51
Standard Mode Alarm System fault finding.....	52
Waste electrical and electronic equipment	52

3E3115 i-Series Alarm System User Manual

Important Information.....	55
i-Series Alarm System	56
Quick Installation Guide.....	57
Advanced Features	58
LED Status Indicators	64
Fault Finding	64
Specifications.....	64
External Battery	64

IMPORTANT INFORMATION



WARNING: Read all instructions. Save these instructions.

- **Warning:** The appliance is not intended for use by young children or infirm persons without supervision.
- Young children should be supervised to ensure that they do not play with the appliance.
- Regularly inspect the supply cord, cables, wires and energizer for any damage. If found damaged in any way, immediately cease use of the energizer and return it to a Gallagher Authorised Service Centre for repair in order to avoid a hazard.
- Energizer must be installed in a shelter and the supply cord must not be handled when the ambient temperature is below +5 deg C.
- It is recommended that, in all areas where there is a likely presence of unsupervised children who will be unaware of the dangers of electric fencing, that a suitably rated current limiting device having a resistance of not less than 500 ohms be connected between the energizer and the electric fence in this area.
- Check your local council for specific regulations.
- Fence wiring should be installed well away from any telephone or telegraph line or radio aerial.
- Well maintained electric fences kept clear of vegetation with high quality insulation are extremely unlikely to cause fires. In times of extreme fire risk, disconnect energizer.
- Do not mount in places exposed to heat sources (e.g. a sun heated metal wall).
- Refer servicing to a Gallagher Authorised Service Centre.
- Do not connect two Energizers to the same earth system.
- If connected to a mains power circuit that doesn't have a Residual Current Device (RCD), then a plug-in RCD should always be used.
- Ensure the Energizer is fully protected from rain, condensation and other sources of moisture.
- Ensure the Energizer has adequate ventilation.
- Energizers with a Standby mode may turn on or off without warning. The energizer must be disconnected from the mains supply if it needs to be rendered fully inoperative.
- Electric animal fences and their ancillary equipment shall be installed, operated and maintained so that they cause no electrical hazard to persons, animals or their surroundings.
- Do NOT become entangled in the fence. Avoid electric fence constructions that are likely to lead to the entanglement of animals or persons.
- **WARNING - INSTALLERS/USERS SHOULD NOTE:**
 Avoid contacting the fence with the head, mouth, neck or torso.
 Do not climb over, through or under a multi-wire electric fence.
 Use a gate or a specially designed crossing point.
- An electric animal fence shall not be supplied from two separate energizers or from independent fence circuits of the same energizer.
- For any two separate electric animal fences, each supplied from a separate energizer independently timed, the distance between the wires of the two electric animal fences shall be at least 2.5m. If this gap is to be closed, this shall be effected by means of electrically non-conductive material or an isolated metal barrier.
- Barbed wire or razor wire shall not be electrified by an energizer.
- A non-electrified fence incorporating barbed wire or razor wire may be used to support one or more off-set electrified wires of an electric animal fence. The supporting devices for the electrified wires shall be constructed so as to ensure that these wires are positioned at a minimum distance of 150 mm from the

vertical plane of the non-electrified wires. The barbed wire and razor wire shall be earthed at regular intervals.

- Follow the energizer manufacturer’s recommendations regarding earthing.
- The energizer earth electrode should penetrate the ground to a depth of at least 1 m (3 ft) and not be within 10 m (33 ft) of any power, telecommunications or other system.
- Use high voltage lead-out cable in buildings to effectively insulate from the earthed structural parts of the building and where soil could corrode exposed galvanized wire. Do not use household electrical cable.
- Connecting leads that are run underground shall be run in conduit of insulating material or else insulated high voltage lead-out cable shall be used. Care must be taken to avoid damage to the connecting leads due to the effects of animal hooves or tractor wheels sinking into the ground.
- Connecting leads shall not be installed in the same conduit as the mains supply wiring, communication cables or data cables.
- Connecting leads and electric animal fence wires shall not cross above overhead power or communication lines.
- Crossings with overhead power lines shall be avoided wherever possible. If such a crossing cannot be avoided it shall be made underneath the power line and as nearly as possible at right angles to it.
- If connecting leads and electric animal fence wires are installed near an overhead power line, the clearances shall not be less than those shown in the table following.

Minimum clearances from power lines for electric animal fences

Power line Voltage V	Clearance m
Less than or equal to 1 000	3
Greater than 1 000 and less than or equal to 33 000	4
Greater than 33 000	8

- If connecting leads and electric animal fence wires are installed near an overhead power line, their height above the ground shall not exceed 3 m
This height applies either side of the orthogonal projection of the outermost conductors of the power line on the ground surface, for a distance of:
 - 2 m for power lines operating at a nominal voltage not exceeding 1 000 V;
 - 15 m for power lines operating at a nominal voltage exceeding 1 000 V.
- Electric animal fences intended for deterring birds, household pet containment or training animals such as cows need only be supplied from low output energizers to obtain satisfactory and safe performance.
- In electric animal fences intended for deterring birds from roosting on buildings, no electric fence wire shall be connected to the energizer earth electrode. A warning sign shall be fitted to every point where persons may gain ready access to the conductors.
- Where an electric animal fence crosses a public pathway, a non-electrified gate shall be incorporated in the electric animal fence at that point or a crossing by means of stiles shall be provided. At any such crossing, the adjacent electrified wires shall carry warning signs.
- Any part of an electric animal fence that is installed along a public road or pathway shall be identified by electric fence warning signs (G6020) at regular intervals that are securely fastened to the fence posts or firmly clamped to the fence wires.
- The size of the warning sign shall be at least 100mm x 200mm.
- The background colour of both sides of the warning sign shall be yellow. The inscription on the sign shall be black and shall be either:
 - the substance of “CAUTION: Electric Fence” or,
 - the symbol shown:
- The inscription shall be indelible, inscribed on both sides of the warning sign and have a height of at least 25mm.
- Ensure that all mains operated, ancillary equipment connected to the electric animal fence circuit provides a degree of isolation between the fence circuit and the supply mains equivalent to that provided by the energizer.
- Protection from the weather shall be provided for the ancillary equipment unless this equipment is certified by the manufacturer as being suitable for use outdoors, and is of a type with a minimum degree of protection IPX4.

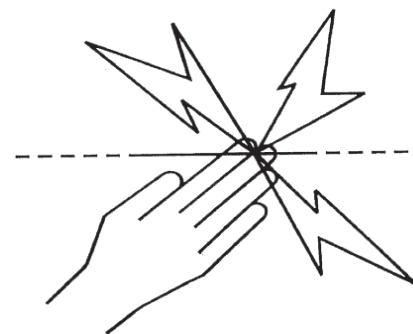

This energizer complies with international safety regulations and is manufactured to international standards. Gallagher reserves the right to make changes without notice to any product specification to improve reliability, function or design. E & OE.

The author thanks the International Electrotechnical Commission (IEC) for permission to reproduce Information from its International Publication 60335-2-76 ed.2.0 (2002). All such extracts are copyright of IEC, Geneva, Switzerland. All rights reserved. Further information on the IEC is available from www.iec.ch. IEC has no responsibility for the placement and context in which the extracts and contents are reproduced by the author, nor is IEC in any way responsible for the other content or accuracy therein.

SERVICE OF DOUBLE-INSULATED APPLIANCES

In a double-insulated controller, two systems of insulation are provided instead of grounding. No equipment grounding means is provided in the supply cord of a double-insulated controller, nor should a means for equipment grounding be added to the controller. Servicing a double-insulated controller requires extreme care and knowledge of the system, and should be done only by qualified service personnel. Replacement parts of a double insulated controller must be identical to the parts they replace. A double insulated controller is marked with the words "DOUBLE INSULATION" or "DOUBLE INSULATED". The symbol for double insulation  may also be marked on the appliance.

HOW THE ENERGIZER WORKS

The energizer sends electrical pulses along the fence line, about one second apart. These pulses give the animal a short, sharp, but safe shock. The shock doesn't harm the animal. It is sufficiently memorable that the animal never forgets the shock, and will avoid the fence.

Practical Hints

- Check your local ordinance on fencing laws: local laws may require a permit before use.
- Check the fence periodically. Remove any fallen branches, weeds or shrubs because these will cause the fence to short out and will reduce animal control.
- All animals need time to learn to respect the fence. It may take several days to train the animal and the fence may require minor adjustments.
- Animals that are prone to jumping may be difficult to confine. You may need to try different fence heights to determine the best height.
- Use top quality insulators: low quality or cracked insulators and plastic tubing are not recommended because they will cause shorting.
- Use joint clamps on all steel wire connections to ensure a high quality circuit.
- This energizer must be earthed using galvanised metal earth stakes to ensure the electric fence works correctly.
- Double Insulated Cable should be used in buildings, under gateways and where soil could corrode exposed galvanised wire. Never use household electrical cable. It is made for a maximum of 600 volts and will leak electricity.
- On permanent power fencing, use high tensile 12.5 gauge (2.5 mm) wire.

Note: Approvals & Standards - FCC

This equipment has been tested and found to comply with the limits for a Class A digital device, pursuant to part 15 of the FCC Rules. These limits are designed to provide reasonable protection against harmful interference when the equipment is operated in a commercial environment. This equipment generates, uses and can radiate radio frequency energy and, if not installed and used in accordance with the instruction manual, may cause harmful interference to radio communications. Operation of this equipment in a residential area is likely to cause harmful interference in which case the user will be required to correct the interference at his own expense.

INSTALLATION GUIDE

Energizer Controller

Mount the controller on a flat surface within 3m (10ft) of the energizer, or up to 50m (160ft) if using an RJ-12 extension cable*. The controller is suitable for indoor and outdoor use. Alternatively, the bracket at the back of the controller can be extended to allow it to stand on a desk or bench.



- Remove the black bezel surround from the controller allowing access to the 4 mounting holes in each corner. The 4 mounting screws are located on the back surface of the controller.
- Using the template on the back page as a drilling guide, drill 4 x 2.5mm (7/64") holes (A,B,C & D) at least 35mm (1.4") deep.
- Fix the screws provided into the wall through the mounting holes in each corner. Place the black bezel on the controller.
- Route the controller cable to the energizer and plug it into the data connector on the back cover.

Step 1. Install the Energizer

Mount the energizer on a wall, under cover and out of reach of children. Install where there is no risk of the energizer incurring fire or mechanical damage and if possible away from heavy electrical equipment eg. pumps or other items that may cause electrical interference.



- Using the separate template, drill 2 x 3.2mm (1/8") holes (E & F) or (G & H).
- Fix the screws provided into the wall leaving the head of the screw about 12mm (1/2") out from the wall.
- Place the energizer over and slide down onto the mounting screws.
- Remove orange terminal cover to expose Fence, Earth and Reference Earth terminals.

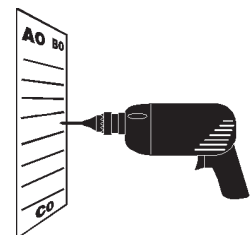

a

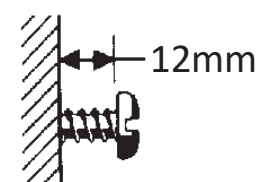

b

* To achieve greater distances up to 200m, a lower resistance cable is required.

Step 2. Install the Earth system

Buildings and gates for example, can become electrified with fence voltages if the energizer is improperly earthed.

Follow earthing instructions carefully.

- a) Install at least 5 x 2.1m (7ft) galvanised earth stakes into damp soil where possible. In dry conditions or in low mineral content soil more earth stakes may be required. Earth stakes must be at least 3m (10ft) apart and at least 10m (33ft) away from any mains cabling, telephone cabling, water pipes or building earth. Do not connect the earth terminal to any building metal work or framing.
- b) To attach the earth cable:
 1. Using Underground Cable (G627) remove 5cm (2") of plastic coating from one end of the cable wire and connect to the green (⏏) terminal on the energizer.
 2. Attach the cable to the earth system by removing 10cm (4") of insulation from the cable at each Earth Stake (G879) and then clamp the exposed wire to each stake using an Earth Clamp (G876).
 3. Tighten the clamp.

For further instructions on the earth (ground) system see the Gallagher Power Fence™ Manual.

Note: Poor grounding can cause interference on telephone lines, radios and televisions. This can be recognised by a clicking sound on telephones.

Reference Earth

An additional earth stake is required to measure the earth system performance.

- a) Install a single galvanised stake (G878 / G879) at least 60cm (2ft) long, at least 10m (33ft) from the main energizer earth system and at least 10m (33ft) from any mains cabling, telephone cabling, water pipes or building earth.
- b) Using Underground Cable (G627) connect the reference earth stake to the black (⏏) terminal on the energizer.

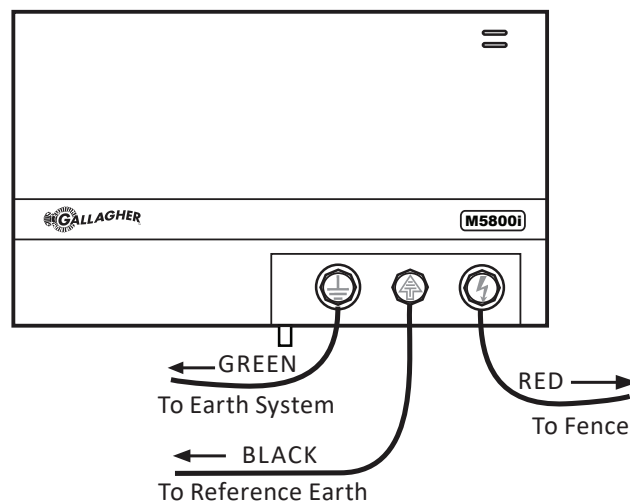

Step 3. Connect the fence

- a) Connect the energizer's red output () terminal to the fence using Underground Cable (G627). Remove 5cm (2") of plastic coating from one end of the cable. Unscrew the red (FENCE) terminal and insert the wire through the terminal slot. Screw the terminal closed, ensuring the wire is firmly clamped.
- b) Attach the other end of the cable to the fence using a Joint Clamp (G603).

For instructions on fence installation see the Gallagher Power Fence™ Manual or go to www.gallagher.com.

Step 4. Turn the Energizer On

- a) Plug the energizer into a power outlet and switch ON.
- b) Check that the Power On LED on the front of the energizer is green.
- c) Re-attach the orange terminal cover.

IMPORTANT: Readings will change as the fence conditions change. This is the Energizer monitoring the fence and Energizer performance. Read the section "Understanding your Energizer Controller" (p.13) for a complete understanding of the display and alarms.

UNDERSTANDING YOUR ENERGIZER



UNDERSTANDING YOUR ENERGIZER CONTROLLER

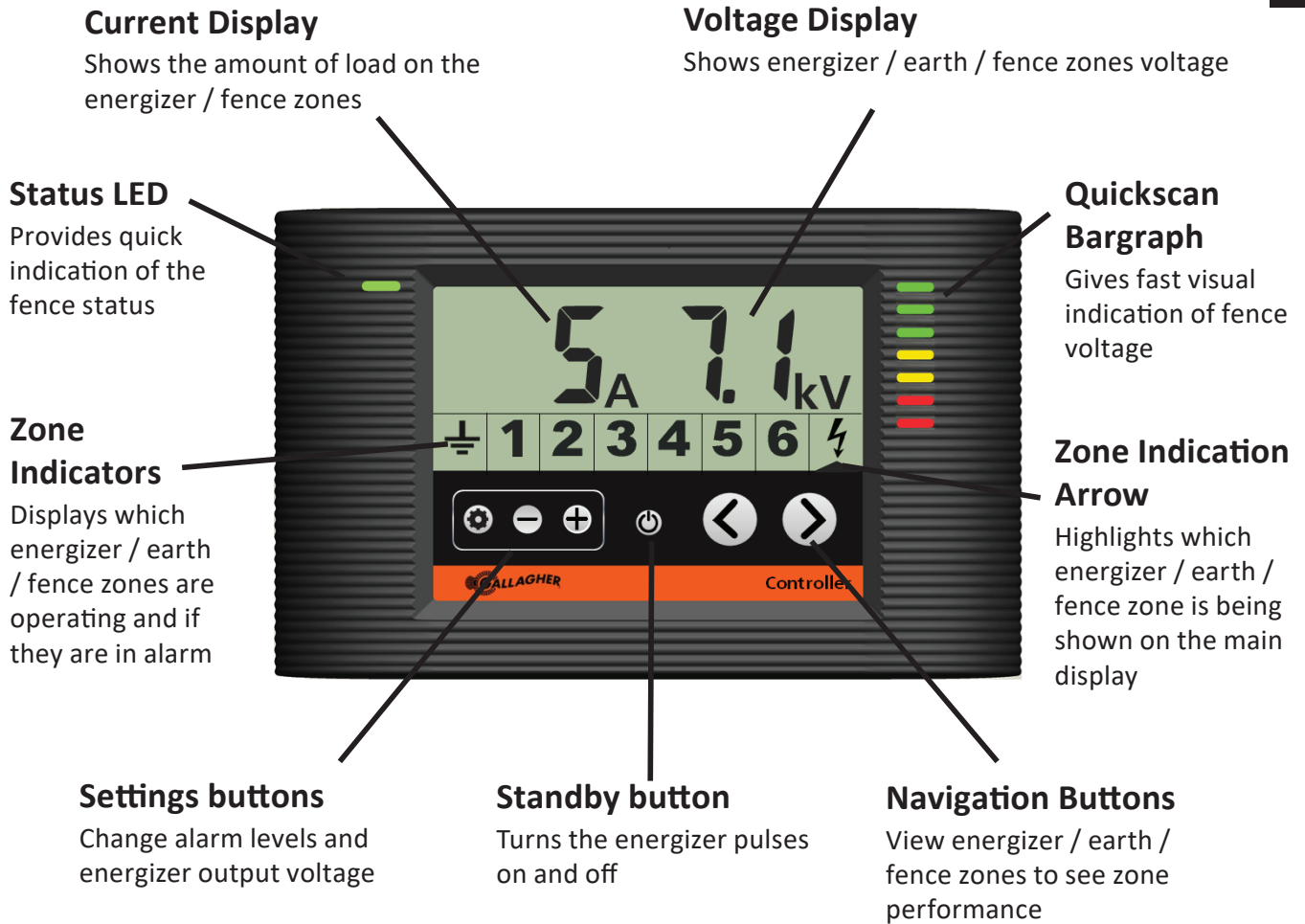

Status LED

Green	The energizer and fence are operating normally
Red	The energizer has detected a fault. Check the LCD screen to determine where the problem is.
Flashing Red	The energizer output voltage is low.

Quickscan Bargraph

The Quickscan bargraph gives quick visual indication of the energizer output voltage. Each bar illuminated represents approximately 1KV output.

Green Segments	Your fence is performing well. No attention is required.
Yellow Segments	Your fence is under some load but is still delivering an effective shock.
Red Segments	Your fence is under heavy load and requires maintenance.



Current Display

The output current indicates how hard your energizer is working. When your fence is in good condition this reading will be low, typically under 15 Amps. As the load on the fence increases the current will rise and output voltage will fall. The output current will typically change with fence conditions, seasonal grass growth and wet weather. A high output current, typically over 40 Amps indicates there is a very high load or short circuit on the fence.

Voltage Display

Output voltage is an indication of how effective the shock is on your fence. It is generally recommended to have 3KV or above on the fence at any time. If the output voltage is too low there will not be enough voltage to 'break' through the animals hide and deliver an effective shock.

Zone Indicators

The zone indicators show what zones are active on the fence system. The Energizer zone () and Earth zone () are always available. Zones 1 – 6 can be added by installing a combination of up to 6 Fence Monitors or Alarm Systems. See *Accessories* (p.19).

Navigation Buttons

The navigation buttons allow you to view the performance of different areas of your fence system. By pressing (<) or (>) you can scroll through the zone indicators to view fence or earth voltage. The zone you are looking at is highlighted by the zone indication arrow ()

Standby Button

Pressing the standby button turns the energizer pulses on or off.

Settings Buttons

The settings buttons allow you to adjust the alarm levels and output voltage of the energizer. Pressing the setup button () turns off the energizer pulses and enters setup mode. If no further buttons are pressed within 10 seconds the energizer automatically exits setup mode and starts pulsing as normal.

Other Icons

The controller may occasionally display other icons for your information.



Energizer over-temperature. The energizer has detected that its internal temperature is too high to operate safely, has automatically slowed its pulse rate down and may shut down until the temperature has decreased.



Settings mode. The user has entered the controller setup mode.



Standby mode. The energizer has been placed into standby and has stopped pulsing. Press the standby button to resume normal operation.

Using The Energizer Controller

Energizer Output and Alarms

The energizer output is the default screen display mode. The zone indicator arrow is highlighting the energizer zone (⚡) and the energizer output voltage is 7.3KV in this case.

The quickscan bargraph display is also indicating an output voltage of over 7KV.

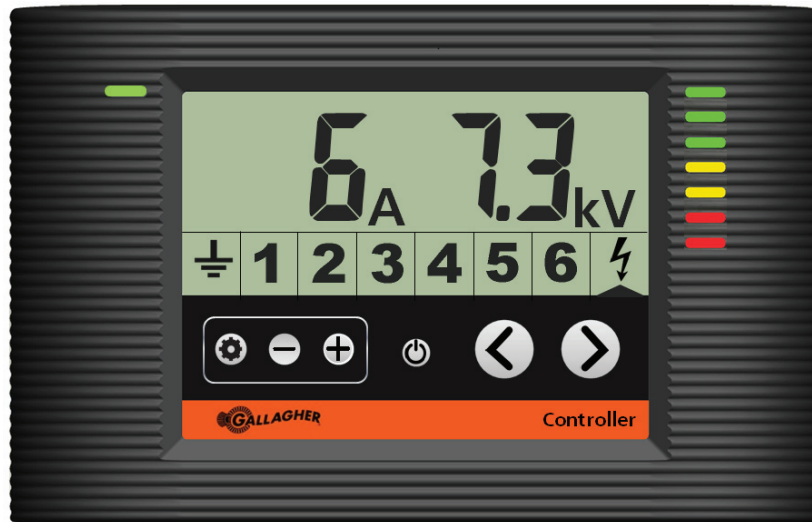

Controller showing the energizer operating normally

Voltage Alarm

If the energizer output voltage falls below the alarm level (default 3KV) then the status LED will flash red and the energizer zone indicator will become highlighted.



Controller showing the energizer in output alarm

Current Alarm

The factory default setting is current alarm disabled (shown by --). To improve your ability to find faults before your fence becomes ineffective (voltage too low), Gallagher recommend setting the current alarm 10A above normal operation.

Many events can cause the current to increase, including rainfall, grass growth, broken fences and failed insulators. If the current goes above the alarm level you have set, then the Energizer icon (⚡) will flash and the status LED will flash red.



Controller showing the energizer in current alarm



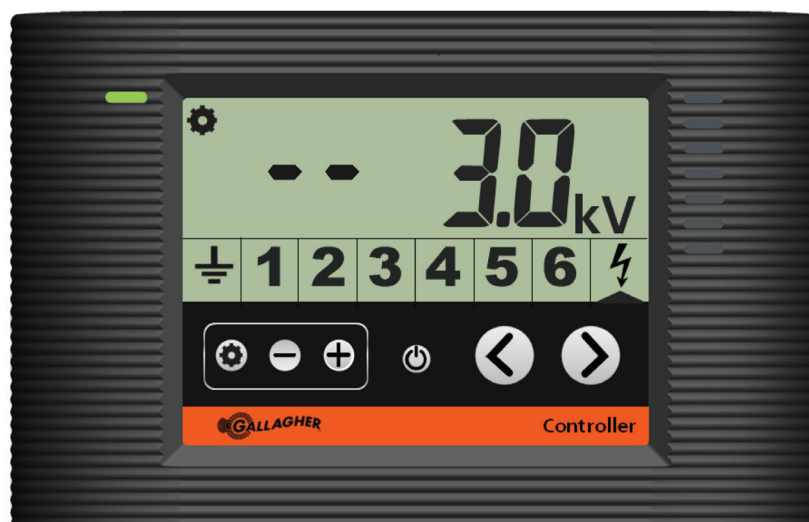

Adjusting / Turning Off Alarms

- Press the setup button (⚙️).
- Press the navigation buttons (< or >) to move the zone indication arrow (▲) over the desired zone, which will flash when selected.
- Press (- or +) to adjust the zone alarm level.
- To disable an alarm press (-) until the display shows (- -).
- To exit, press the setup button (⚙️) or wait 10 seconds.



Controller showing the default energizer alarm setup with current disabled and voltage at 3.0KV

Quick Reference

Display	Description	Solution
	Normal active zone	Record zone current and voltage as a reference.
	Flashing zone. Current alarm	Current is too high. Reduce the loading on your fence by fixing faults or increase the current alarm level.
	Reverse icon. Voltage alarm	Voltage is too low and may not be an effective deterrent. Immediately find the fault on the fence.
	Flashing reverse icon. Current and Voltage Alarm	The voltage is too low and may not be an effective deterrent. The current is above the alarm limit representing more power loss.

HANDY HINT

A card is included with your energizer to allow you to record fence voltage and current. Do this when your fence is operating well and store the card by the energizer. This will greatly assist with fault finding.

Earth System Voltage and Alarm

View the earth system performance by pressing the navigation buttons (< or >) while the energizer is operating until the zone indication arrow (▲) is highlighting the earth zone (⏚). The earth voltage will be displayed if a reference earth stake is installed. If there is no reference earth it will display 0.0KV. If the earth voltage rises above the earth alarm level (default 0.5KV) the status LED will flash red, the earth zone indicator will be highlighted and the internal buzzer will sound on the energizer. The buzzer can be muted by pressing any key on the controller.

See *Adjusting / Turning Off Alarms* (p.16) to adjust or turn off the earth system alarm.

HANDY HINT

Testing the earth system

- Turn the energizer off. At least 40m (130ft) along the fence line drive a steel stake into damp soil and connect it to the fence wire.
- Turn the energizer on and wait 30 seconds. Check the earth system voltage using the navigation keys. The earth voltage should be 0.2 – 0.3KV or less. If it is higher add earth stakes until 0.2-0.3KV is achieved. In dry conditions or areas with low mineral content soil an earth return system may be required as described in the Gallagher Power Fence™ Manual or visit www.gallagher.com.

Fence Zone 1–6

View the Fence Zone performances by pressing the navigation buttons (< or >) until the zone indication arrow is highlighting the desired fence zone (1–6). The fence zones voltage, current and alarm information is displayed in the same way as the Energizer output information. See *Energizer Output and Alarms* section (p.15).

To adjust or turn off the fence zone alarms, see *Adjusting/Turning Off Alarms* section (p.16).

Low Battery

When viewing a zone, if the battery icon is displayed, then the zone device needs a battery replacement.



Controller showing zone 2 with a low battery

Adjusting the energizer output voltage

- Press the setup button (⚙️) to enter setup mode and use the navigation buttons (< or >) to highlight the quickscan bargraph display (it will start flashing).
- Press (+ or -) to adjust the output voltage up or down. The output voltage can be adjusted from 4.5KV to 8KV. The factory default setting is 8KV.
- To exit the setup mode wait 10 seconds or press the setup button (⚙️).



Controller showing the output voltage being adjusted

ACCESSORIES

Gallagher Fence Monitor G51000

Use up to 6 Fence Monitors to turn your fence into a zoned system that will enable you to immediately determine which fence zone is in fault.

When a zone falls below a set voltage level, an alarm is sent to the Energizer Controller indicating that zone is below the set alarm voltage.

Gallagher Energizer Remote and Fault Finder G50700

The Gallagher Energizer Remote and Fault Finder displays which zone(s) are in fault and can then be used to locate the fault within that zone. Power to the fence at the fault location can be turned off and on using the Remote, allowing a safe and convenient repair.

Gallagher SMS Energizer Controller G56760

Adding an SMS Energizer Controller provides text messaging control and information direct to your mobile phone. This gives instant notice of fence faults and provides peace of mind.

Important: Only 1 SMS Energizer Controller can be used per energizer.

Using your mobile phone you can:

- Receive automatic alerts when the energizer detects a fence fault
- Turn your energizer on or off
- Query fence voltage, earth system performance and any alarm zones installed
- Receive alerts due to mains power failure

The SMS Energizer Controller is safe and secure, it responds to a maximum of 2 registered mobile phone numbers.

Gallagher Alarm System G57900

Create a security zone for your property by adding an Alarm System with in-built fence monitoring technology.

Connected to the Energizer and Controller via a daisy chain connection, the Alarm System has input terminals to connect to the end of a section of fence and a reference earth peg, enabling that section of fence to be monitored for security breaches. For example, an electric gate entrance to a farm building can be set up to alarm when opened.

The Alarm System can drive an external siren and strobe light, or provide dry contact relays to an alarm panel or auto dialer.

To purchase any of the accessories listed, see your local Gallagher dealer.

TROUBLESHOOTING

Problem	Causes	Solution
Energizer has started to run slowly 	The internal temperature of the energizer is too high	Mount the energizer in a cool area, out of direct sun and with adequate ventilation.
Displaying Error 11	Mains voltage is too high	Have your power supply checked by a professional electrician.
Displaying Error 12	Mains voltage is too low	Have your power supply checked by a professional electrician.
Displaying Error 14 - 19	Internal energizer fault	Turn energizer off for 30 seconds then turn back on. If the error remains return the energizer to your Gallagher dealer for servicing.
Displaying Error 21	Dead zone	Check that the zone device is connected and working correctly.
Energizer output voltage is low	There is a fault on the fence	Remove any excess grass growth or short circuits on the fence.
Earth voltage is too high	Earth system is inadequate	Check connections to the earth system. Add extra earth stakes.
No output and display shows (--)	Energizer is in standby mode	Exit standby mode by pressing the standby button on the controller.

Save these instructions

WASTE ELECTRICAL AND ELECTRONIC EQUIPMENT



This symbol on the product indicates that this product, packaging and with special care of the battery must not be disposed of with other waste. Instead, it is your responsibility to dispose of your waste equipment by handing it over to a designated collection point for the recycling of waste electrical and electronic equipment. The separate collection and recycling of your waste equipment at the time of disposal will help conserve natural resources and ensure that it is recycled in a manner that protects human health and the environment. For more information about where you can drop off your waste equipment for recycling, please contact your local city recycling office or the dealer from whom you purchased the product.











ENERGIZER REMOTE & FAULT FINDER

Contents

3E2749 Remote & Fault Finder User Manual

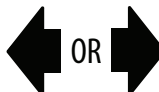
Remote Readings	23
Installing the battery.....	24
Features	24
Checking your fence and finding faults.....	25
Detecting Alarms	26
Turning the Energizer On / Off (Standby)	26
Using your Remote with multiple Energizers.....	27
Understanding your Electric Fence	29

REMOTE READINGS

	<p>Liquid Crystal Display This is the full range of symbols. The meaning of each symbol is detailed below.</p>
	<p>Standby Indicates the energizer is in Standby mode.</p>
	<p>Energizer status</p>
	<p>Voltage Display</p>
	<p>Current Display</p>
	<p>Direction of current flow</p>
	<p>Fence Zone indicators Displays which fence zones are operating and if they are in alarm.</p>
	<p>Low battery</p>
	<p>New channel Displayed when Remote is searching for a new energizer.</p>

INSTALLING THE BATTERY

Always use 9V alkaline batteries for best performance.

1. Turn the battery compartment screw left 90°.
2. Remove the battery cover.
3. Fit the battery.
4. Replace the cover.
5. Turn the screw right, to fix the cover in place.



Note:

The remote battery has a life of approximately 6 months. A flat battery may give false measurements so replace the battery when the icon shows.

FEATURES

The Gallagher Energizer Remote and Fault Finder enables you to do the following:

- Measure fence voltage and current
- Detect and find fence faults
- Check the status of the energizer and fence monitors / alarm systems.
- Turn the energizer on or off from any location on the fence.



CHECKING YOUR FENCE AND FINDING FAULTS

1. Place the fence wire in the fence connections slot.
2. Hold until the following information appears on the display.

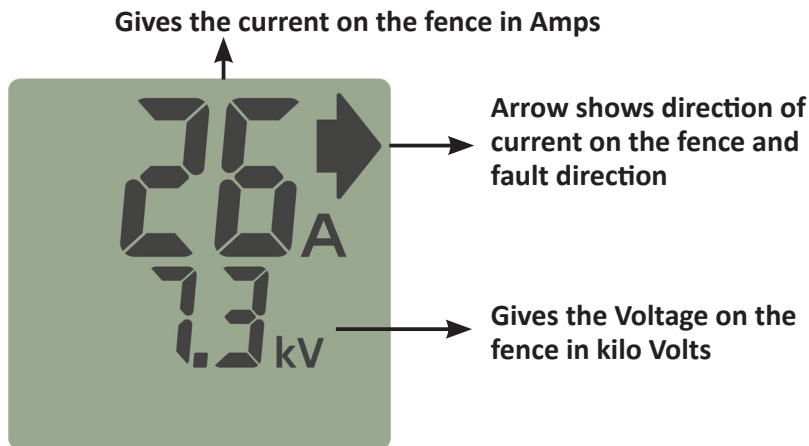

Handy Hint: For improved performance of the Remote, your hand needs to make contact with the grounding plate on the back of the Remote.

How to find faults on your fence

The current reading (Amps) will be high when there is a fault on the fence.

1. Following the direction of the current, take readings approximately every 50 - 100m or at junction points along your fence line.

Note: At a junction point, follow the wire with the highest current flow.

2. A fault is indicated by a drop in current flow between two checkpoints. The fault will be somewhere between the two checkpoints.
3. To narrow down location of the fault, work back along the fence checking the current flow at shorter intervals.
4. Correct the fault.
5. After correcting the fault you should see the current reading drop and the voltage go up. If not, check for further faults.

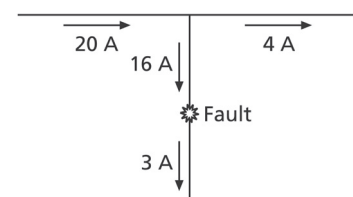

Note: Multiwire fences connected in parallel will have similar current flowing in each wire. To get the total fence current flow, add together the current flow in each wire.

DETECTING ALARMS

You can communicate with the devices operating on your fence by pressing the  button.

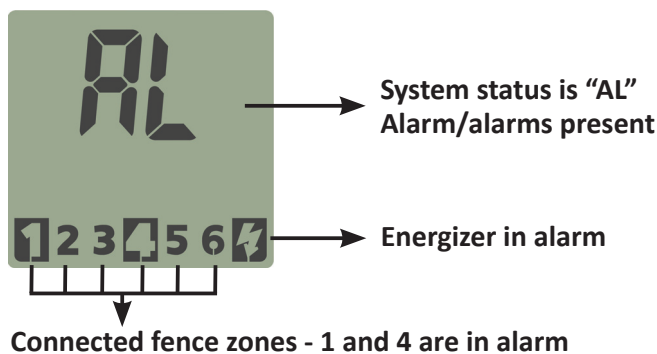
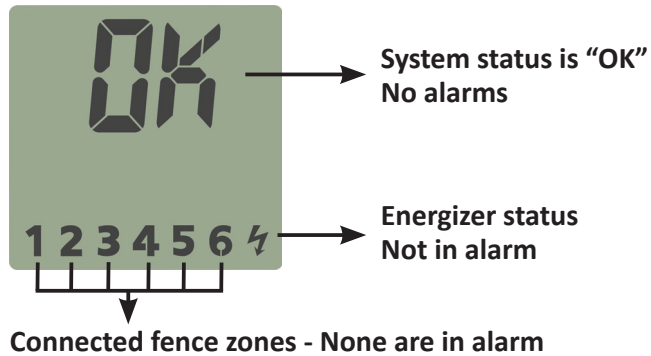

TURNING THE ENERGIZER ON / OFF (STANDBY)

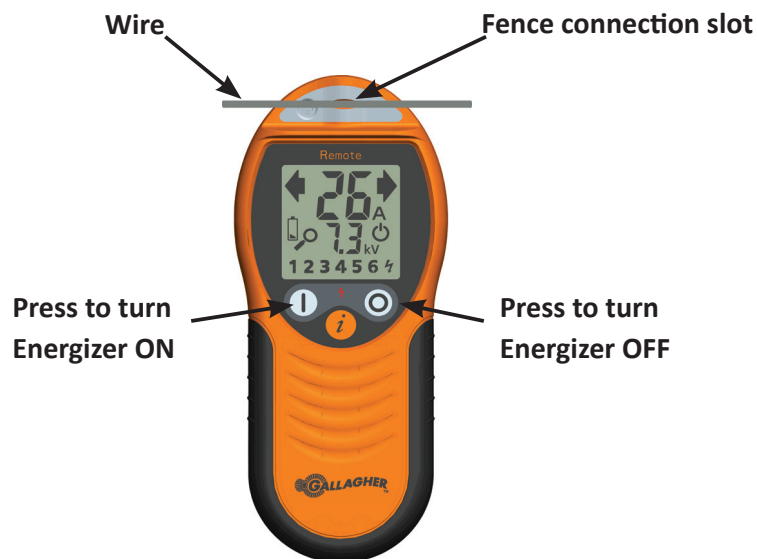

Note: Hold the Remote on the fence until the display shows the energizer is on or off.



USING YOUR REMOTE WITH MULTIPLE ENERGIZERS

The Remote has nine channels that can be “tuned in” to a specific energizer, enabling the Remote to control up to nine energizers.

Note: You do **NOT** need to register your Remote with the Energizer if you are only using one Energizer.

Adding a channel

To add a new energizer to the list of channels, complete the following:

1. Hold down any two buttons (ON/OFF/Inquiry) for 3 seconds or more.
The Remote display scrolls through all the “filled” channels. Before returning back to 1, a “new” channel is indicated by the magnifying glass icon . Once this icon is displayed, release the button.
2. Hold the fence connection slot against a wire connected to the new energizer.
3. Press any button to start the automatic tuning process.
On successful tuning, the magnifying glass icon is cleared and the new energizer channel number is displayed. If the tuning is unsuccessful, the reverse lightning bolt symbol  will flash.

Handy Hint: To remember which channel number is set to each energizer, use the table at the back of this manual to record it.

Changing channels

1. Hold down any two buttons for 3 seconds.
2. The Remote display scrolls through all the “filled” channels.
3. Release the buttons when the energizer channel you wish to communicate with is displayed.

Deleting a channel

1. Hold down any two buttons for 3 seconds.
The Remote display scrolls through all the “filled” channels.
2. Release the buttons when the energizer channel you wish to delete is displayed.
3. Press and hold any two buttons for 6 seconds.
After 3 seconds the channel number will start to flash for a further 3 seconds. If both the buttons are held until after the flashing period, the channel will be deleted and the first available channel displayed.

Note: When the battery is removed from the Remote, all channel information is retained. However, when the battery is replaced, the channel selection will **reset to the lowest** configured channel.

Use this table to record which channel number is set to each energizer.

Channel	Energizer
1	
2	
3	
4	
5	
6	
7	
8	
9	

UNDERSTANDING YOUR ELECTRIC FENCE

Compare your electric fence to a water supply system.

Fence Voltage = Water Pressure

Electric Current = Water Volume/Flow

A perfectly performing Electric fence is similar to a water system that has a pressure pump (Energizer) at one end and a bung at the other. There would be high water pressure (voltage) and a high flow potential with no water leaking.



When an animal touches this fence there is total delivery of voltage and current for a maximum shock.

A normal electric fence is similar to a water pipe with one or two leaks (faults). While a minor flow of water (current) will flow into these leaks and reduce overall pressure (voltage) at point B, the pressure is still significant enough to deliver enough water (current) at point B as needed.

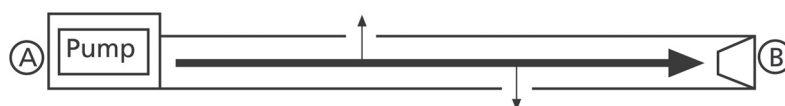

When an animal touches the fence, there is still sufficient voltage and current to deliver an effective shock.

An electric fence with a substantial fault on the fence line is similar to a water system with a major leak. Hence you will see significant flow of water (current) along the pipe to this leak. As most of the water is flowing out of this leak very little water (current) reaches point B.



When an animal touches the fence at point B, there is insufficient voltage and current to deliver an effective shock.

Note: To avoid excessive battery use caused by accidental activation, do not leave your Remote on or near the energizer or electric fence.



FENCE MONITOR

Contents

3E2748 Fence Monitor User Manual

Introduction	33
Installation	34
Using your Fence Monitor	37
Choosing an Installation Location	39
Troubleshooting.....	42

INTRODUCTION

By using up to 6 Fence Monitors, you can turn your fence into a zoned system that will enable you to immediately determine which fence zone is in fault.

When a zone falls below a set voltage level, an alarm is sent to the Energizer Controller indicating that zone is below the set alarm voltage.

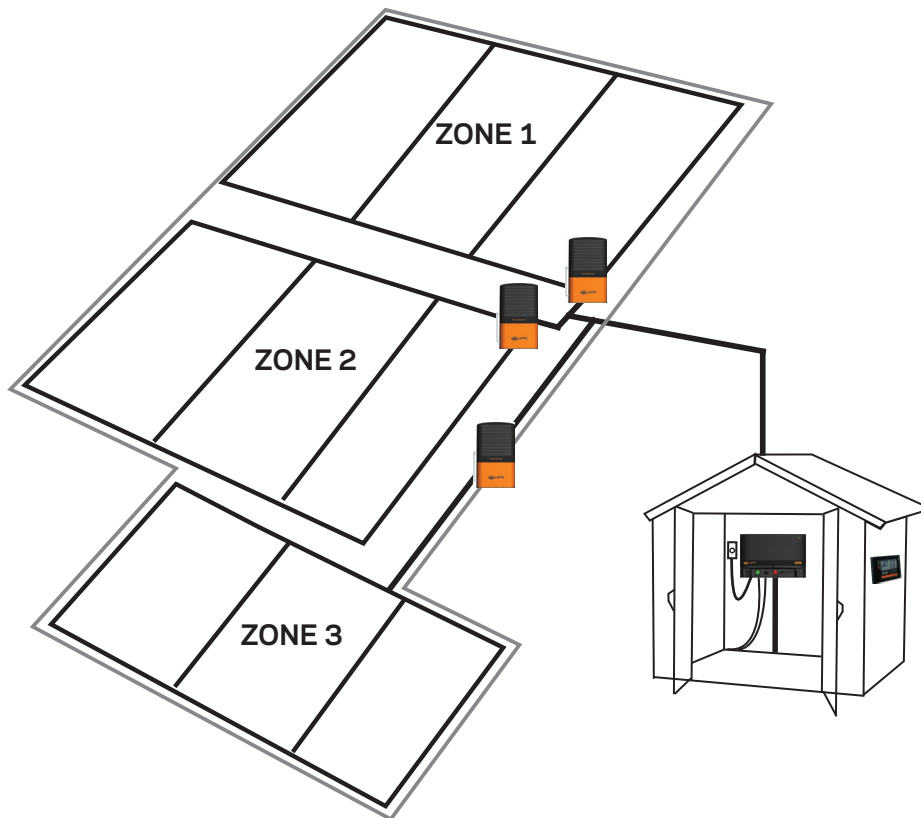

Kit Contents

The following contents are included with your Fence Monitor:

- 2 mounting screws
- Stock protection wire
- 2 cable ties
- Battery holder
- 6 AA alkaline batteries

Note: Earth stake is not included. It is recommended you use a Gallagher G87800 earth stake or similar.

INSTALLATION

For how to set up fence zones on your farm, see *Choosing an Installation Location* (p. 39)

Step 1:

Remove the cover and the battery holder.



Step 2:

Mount the unit to a post in either of the following ways:
Screw to a wooden post (diagram A)

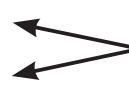
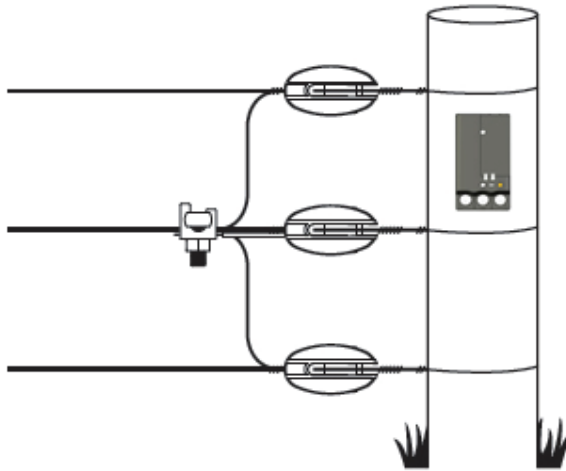

Screw holes for
mounting to a
wooden post

Diagram A

or cable tie to a steel post (diagram B).

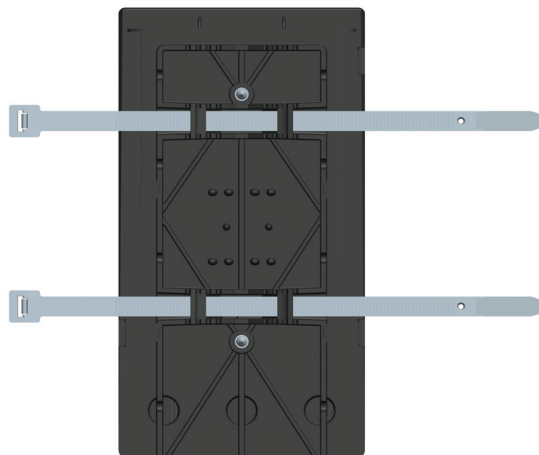
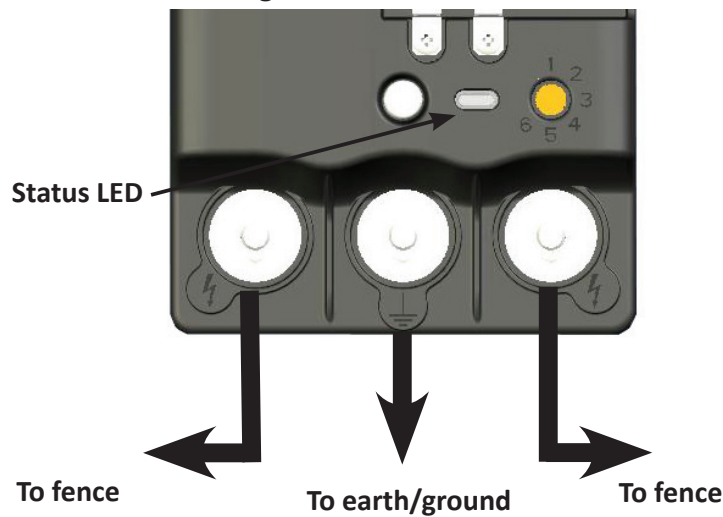

Diagram B

Step 3:

Connect to the fence, energizer and earth stake.



The stock protection wire can be attached to either side of the Fence Monitor (the side most accessible to stock), by placing it under the bolt on one of the Output terminals (⚡).

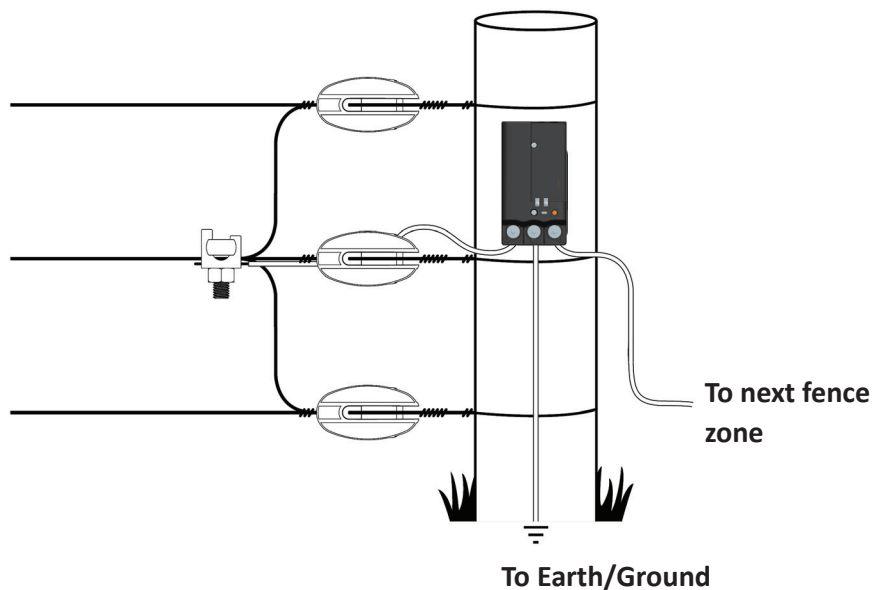

Note: To get an accurate current reading, the power to a zone must pass through the Fence Monitor.

Step 4:

1. Set the fence zone (1-6).

Important: Each Fence Monitor requires a unique zone number.

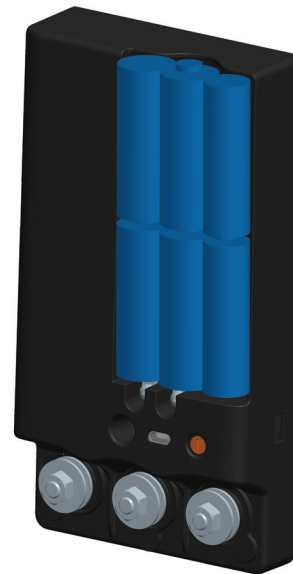

2. Insert batteries into battery holder and replace in the Fence Monitor.

**Step 5:**

Replace the cover.

The electrified stock protection wire is used to stop animals from damaging the Fence Monitor.



USING YOUR FENCE MONITOR

Confirm Fence Monitor is working by checking the zone indicator is displayed on the Energizer Controller.

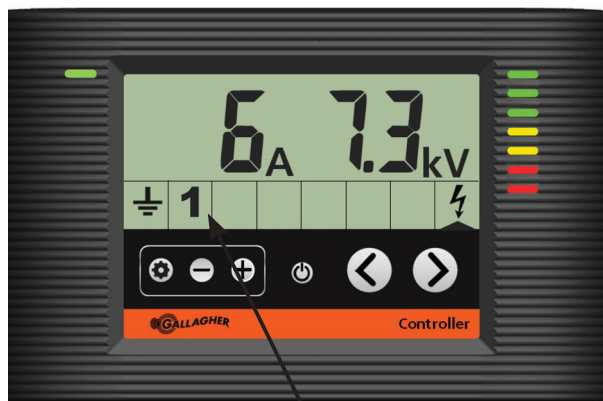

Zone 1 connected

Note: If the zone is not displayed on the Energizer Controller, refer to *Troubleshooting* (p. 42).

Viewing Zone Information

View the fence zone performance by pressing the navigation buttons (< or >) until the zone indication arrow is highlighting the desired fence zone (1 - 6). The fence zones output voltage and alarm information is displayed in the same way as the Energizer output voltage and alarm information.

Changing Zones

To change an existing fence zone number to another zone.

1. Put the Energizer into Standby mode (⏻).
2. Remove the cover.
3. Set orange dial to the required zone.
4. Replace the cover.
5. Turn the Energizer on.
Both the old and new zone numbers will be displayed on the Energizer Controller.

Important: If you do not delete the old zone number, and subsequently try to display the activity for this zone on your Energizer Controller, it will display Er 21.

Deleting an Unused Zone

To delete a zone from the Energizer Controller.

1. Press the Settings button (⚙️).
2. Using the arrow keys, scroll to the unwanted zone number.
3. Hold down the + and - buttons for 6 seconds.

Important Battery Information

- Only use Alkaline (AA) batteries
- Remove batteries when not in use
- Estimated battery life: 1-2 years

Low battery indication is shown on controller as below:



CHOOSING AN INSTALLATION LOCATION

To get the best use of your Fence Monitor, it is wise to make a map of your farm and mark the locations of your Fence Monitors and the associated zones.

To help identify where faults are, the Fence Monitors must be installed in sections of the fence that **supply** current to different parts of the farm. The Fence Monitor can only identify faults in fences that are supplied through the installation location. For best results, Fence Monitors should be installed at specific feeder wires that power specific geographical locations on the farm. See the following examples:

Small Farm

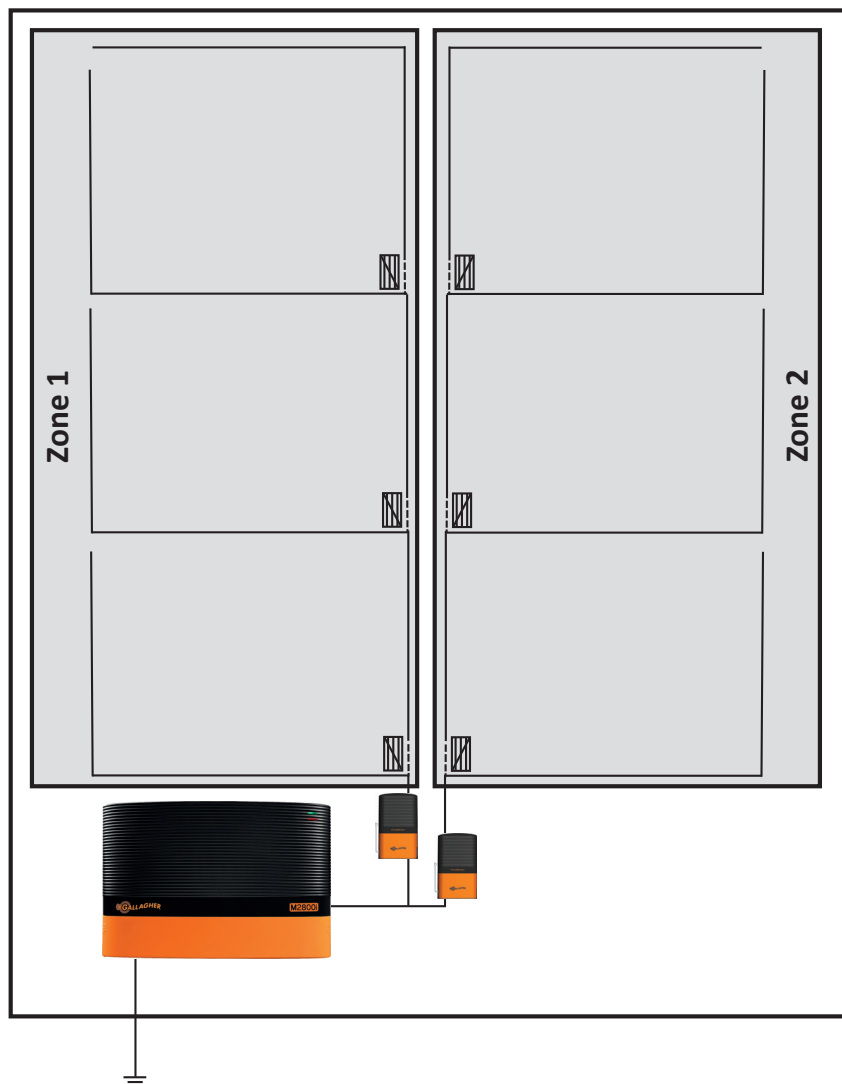

Independent Leadouts

Independent Zones

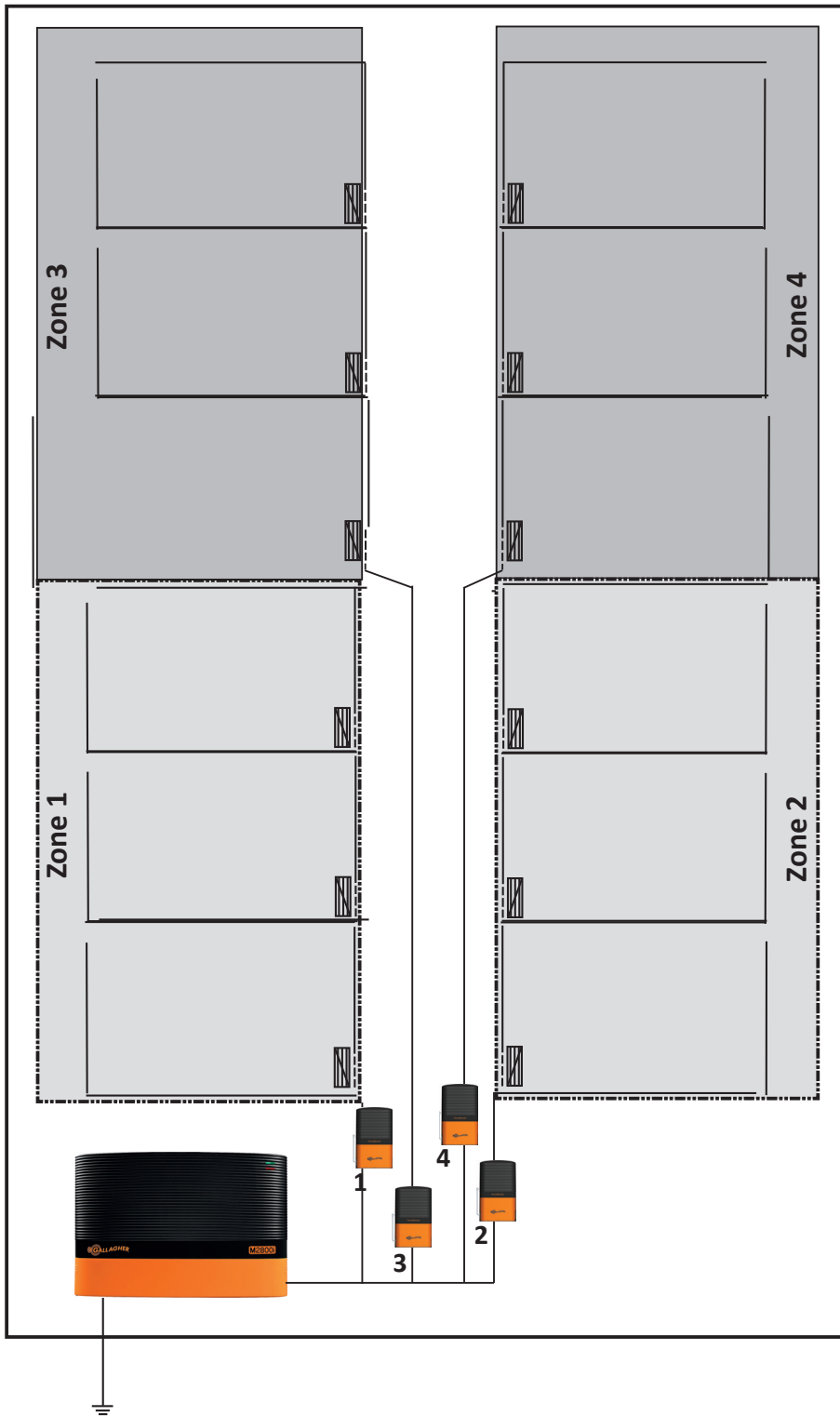

Advanced Fence Zoning

Alternatively, Fence Monitors can be installed on smaller areas within a larger area. If the fault is located in the smaller area and the larger area, then fault is most likely in the smaller area. If only in the larger area, then the fault is in the larger areas but not in the smaller sub area:

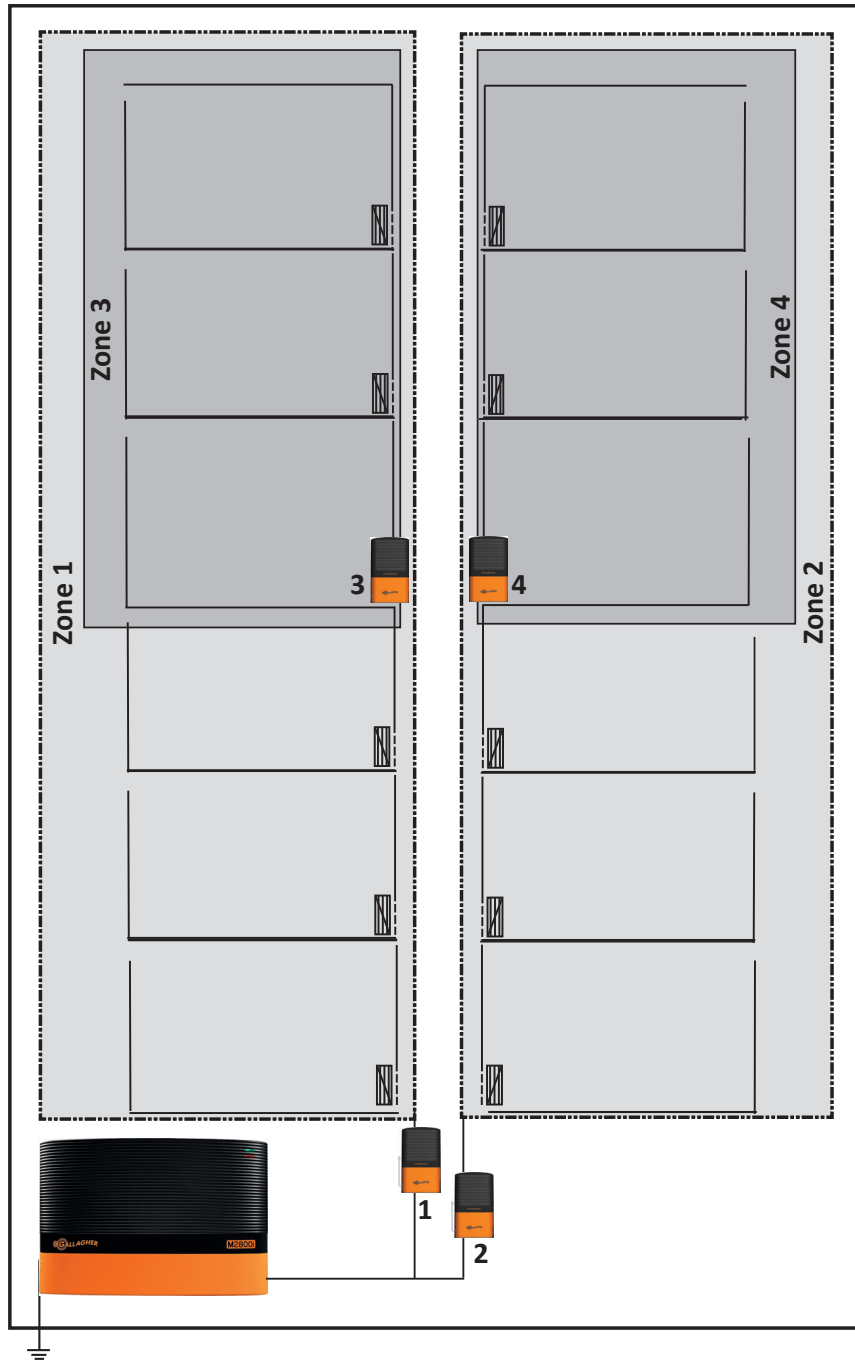

Note: Care should be taken to ensure that there are no cross connections between zones that make fault diagnosis more difficult.

TROUBLESHOOTING

Problem	Causes	Solution
Fence Monitor zone does not appear on the Energizer Controller	Batteries are flat Batteries or battery holder are installed incorrectly Fence Monitor needs resetting There are 2 fence monitors on the same zone The fence voltage is less than 500V The energizer is incorrectly connected to the fence	Replace batteries Install batteries / battery holder correctly Remove battery holder for 5 minutes to reset the Fence Monitor Give each fence zone a unique number. See p. 8. Repair fence Connect your earth system to the earth terminal (on the left), and the fence to the fence terminal (on the right)
Zone current measures lower than expected	Poor Fence Monitor earth Fence installation Batteries are low	Use additional earth stakes Check all power to zone runs through the Fence Monitor Replace batteries
Error 21 is displayed on a fence zone	Communication with Fence Monitor has been lost	Check the Fence Monitor

Status LED

Status LED will only operate once after the Energizer has been turned on.

One flash	Registration sent to Energizer
Two flashes	Registration with Energizer confirmed



SMS ENERGIZER CONTROLLER

Contents

SMS Energizer Controller User Manual

Understanding your SMS Energizer Controller	45
Understanding SMS messages	47
Troubleshooting.....	51
Standard Mode Alarm System fault finding.....	52
Waste electrical and electronic equipment	52

UNDERSTANDING YOUR SMS ENERGIZER CONTROLLER

Purchasing a SIM card

Before installing your SMS Energizer Controller, **you need to purchase** a mobile phone **Standard SIM** card to place inside the module.

It is recommended you purchase a SIM card with a monthly subscription contract to avoid payment top up issues with pre-paid SIM cards. It is also recommended that the SIM card is from the same GSM network as your mobile phone to avoid the risk of inter-network delays.

Note: It is recommended the SIM card is tested in your mobile phone **before** placing it in your SMS Energizer Controller. Only a Standard size SIM is compatible.

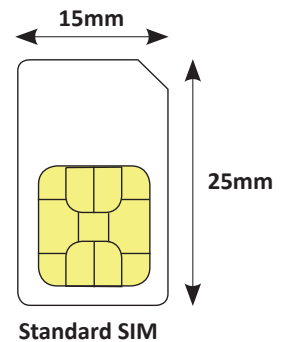

Important: Only 1 SMS Energizer Controller can be used per Energizer.

Please use the GSM card of a provider which guarantees you a sufficient cell reception.

The display of your mobile phone should show a full reception in combination with the GSM card you would like to use in your Gallagher SMS energizer controller.

Installing your SMS Energizer Controller

1. Turn **off** the power to the Energizer.
2. Remove the SMS Energizer Controller cover.
3. Place SIM card in SIM card slot, chip facing down. If your SIM card has a PIN code see your card provider to have the PIN removed.



4. Remove plastic tab from battery connection.

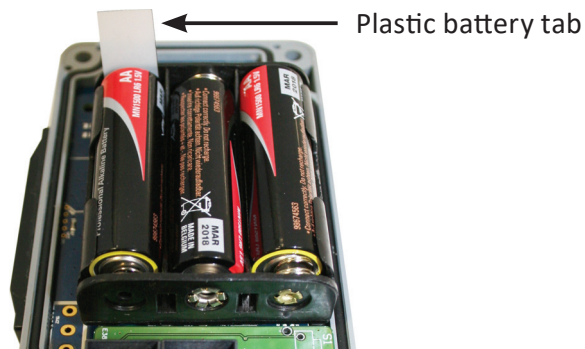

5. Replace cover.

Note: The SMS Energizer Controller will switch to the back-up battery pack when mains power fails.

6. Connect as shown below.

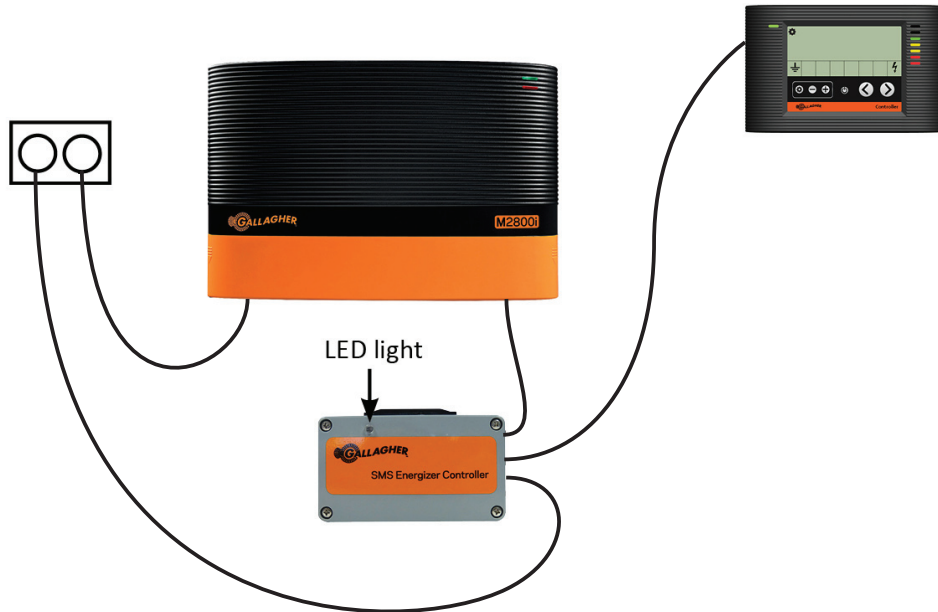

7. Turn both SMS Energizer Controller and Energizer **ON**.

Registering your mobile phone to the SMS Energizer Controller

- Text **REG** to the SIM card phone number inside the SMS Energizer Controller.
- The SMS Energizer Controller will send a response, confirming that your phone has been registered:

SMS to send	SMS received
REG	REG (your mobile number)

Important: A maximum of two phones can be registered to your SMS Controller.

UNDERSTANDING SMS MESSAGES

SMS Status message

When receiving an SMS message (whether this is automatically generated or requested) the following information will always appear first:

SMS: OK/MAINS FAILURE/LOW BATTERY
SIG: (0-100)%

Information	Description
OK	Indicates that the SMS Energizer Controller is on and working.
MAINS FAILURE	Indicates that the mains supply has failed.
LOW BATTERY	Indicates that the SMS Energizer Controller needs new batteries.
SIG	This is the strength of the network signal, which is shown as a percentage.

Receiving automatic SMS Alarm messages

In the event of an alarm, SMS alarm messages will be sent to every registered phone.

SMS received	Explanation of information received
Example 1: SMS:OK SIG:100% EN:OK EA:OK Z1:OK Z2:OK Z3:99A! 2.8kV!	Example 1 shows zones 1 to 3 are connected and working. Zone 1 and 2 have no alarms. Zone 3 has both voltage and current alarms.
Example 2: SMS:OK SIG:100% EN:33A 2.6kV! EA:3.0kV! Z1:15A 2.2kV! Z2:18A 1.9kV!	In Example 2, the Energizer, earth, zone 1 and zone 2 are in voltage alarm.
Example 3: SMS: MAINS FAILURE LOW BATTERY! SIG: 57% EN: MAINS POWER FAILURE	In Example 3, the Energizer and Energizer Controller mains is off. The SMS Energizer Controller batteries are low.

Important: When the power fails, the SMS Energizer Controller will switch to the back-up battery pack. It is recommended that you replace the batteries in the battery pack after any significant main power supply failure, or if there are no such failures, every 1-2 years to ensure power is available when needed.

Requesting action/information

A variety of information and actions can be sent to and received by your Energizer, via the SMS Energizer Controller using your mobile phone. Below is a list of those actions/ information requests:

Action / Information requested	SMS to send	SMS received	Explanation of response
Turn Energizer ON/OFF	ON	ENERGIZER ON POWER ALARM ON RESTORE ON	Energizer is ON
	OFF	ENERGIZER OFF POWER ALARM ON RESTORE ON	Energizer is OFF
Inquiry Status of Energizer System	i	SMS:OK SIG:100% EN:OK EA:OK Z1:10A 8.9kV OK Z2:6A 6.1kV OK	Energizer, Earth and Fence Zones are OK
Turn Energizer mains power alarm on/off Indicates whether an alarm message will be sent or not in the event of the Energizer power supply failing.	A	ENERGIZER ON POWER ALARM ON RESTORE ON	Current status of Energizer
	A ON	ENERGIZER ON POWER ALARM ON RESTORE ON	Power Alarm is ON
	A OFF	ENERGIZER ON POWER ALARM OFF RESTORE ON	Power Alarm is OFF
Turn Restore ON/OFF Indicates whether or not alarm restore messages will be sent to the registered phones.	R ON	ENERGIZER ON POWER ALARM ON RESTORE ON	Restore is ON
	R OFF	ENERGIZER ON POWER ALARM ON RESTORE OFF	Restore is OFF

Important: If symbols **ER21**, **B**, **M** or **T** appear beside zone information when a status message is requested, refer to *Troubleshooting* p. 51.

Notes:

- If an SMS confirmation message is unable to be sent immediately (e.g. due to a drop in signal strength or account payment required), then the SMS Energizer Controller will re-try once every 5 minutes until it is either sent successfully or it fails 3 times at which point the message will be discarded.
- Any commands sent to the SMS Energizer Controller, are not case sensitive.

Advanced Actions

De-registering your mobile phone from the SMS Energizer Controller

- Send SMS **DEREG** to the SMS Energizer Controller.
- The SMS Energizer Controller will send a response to your mobile phone. See table below.

De-registering all mobile phones from the SMS Energizer Controller

- Send SMS **DEREG ALL** to the SMS Energizer Controller.
- The SMS Energizer Controller will send the following response to the requesting mobile phone, notifying of the de-registration.

SMS to send	SMS received
DEREG	REG (mobile number 1) DEREG (mobile number 1) REG (mobile number 2)
DEREG ALL	REG (mobile number 1) REG (mobile number 2) DEREG ALL

Communication Status Indicators

SMS Energizer Controller LED		Explanation
Blue LED	On	Attempting to connect to network
	Flashing fast	Communicating to the network
Red LED	Flashing slow	SIM card access failed
	Flashing fast	Requesting information from the system
Green LED	On	Connected to the network (shown when first turned on)
	Flashing	Sending or receiving a message OK

TROUBLESHOOTING

Problem	Cause	Solution
B appears next to the zone information e.g. Z1:10A 2.9kV! B	Battery power for a zone is low. In Example 1, Zone 1 has no current alarm, but does have a voltage and low battery alarm.	Replace battery
M appears next to the zone information when I request a status message. e.g. Z6:M	Zone has a mains power failure (Alarm Systems only) and is now operating on back-up battery.	Check mains power supply
ER21 appears next to the zone information. e.g. Z5:ER21	Energizer has lost communication with the zone/s	Check that the zone device is connected and working correctly
The registered phones received a response REG (mobile number 1) REG (mobile number 2) REG FULL, ID (mobile number 3) when trying to send REG to register a third phone to the SMS Energizer Controller.	Two phones are already registered to your SMS Energizer Controller.	You will need to de-register one of the two phones. Refer to <i>Advanced Actions</i> p. 50.
Both registered phones have been lost and I need to register my new phone to the SMS Energizer Controller.		You need to reset the SMS Energizer Controller, by first turning the SMS Energizer Controller OFF. Then perform an ON/OFF within one second three times until the LED shows RED before the normal start up sequence.
T appears next to the Energizer information. e.g. EN:0A 6.5kV T!	High temperature alarm.	Improve ventilation around the Energizer to allow it to cool.
EN:ERROR is displayed and energizer has stopped.	Internal fault or mains supply out of range.	Return to Service Centre if error persists.

STANDARD MODE ALARM SYSTEM FAULT FINDING

The following error codes are applicable only when the SMS Controller is connected to an Alarm System in standard mode.

Fault	Solution
SMS message EN: MAINS FAILURE	Check alarm system power supply.
SMS message EN: OA x.ykV!	Alarm system in voltage alarm.
SMS message EN: OA! x.ykV	One of the external inputs activated.
SMS message EN: ERROR	Energizer pulse is missed by the alarm system.

WASTE ELECTRICAL AND ELECTRONIC EQUIPMENT



This symbol on the product or its packaging indicates that this product must not be disposed of with other waste. Instead, it is your responsibility to dispose of your waste equipment by handing it over to a designated collection point for the recycling of waste electrical and electronic equipment. The separate collection and recycling of your waste equipment at the time of disposal will help conserve natural resources and ensure that it is recycled in a manner that protects human health and the environment. For more information about where you can drop off your waste equipment for recycling, please contact your local city recycling office or the dealer from whom you purchased the product.



ALARM SYSTEM

Contents

3E3115 Alarm System User Manual

Important Information.....	55
i-Series Alarm System	56
Quick Installation Guide.....	57
Advanced Features	58
LED Status Indicators	64
Fault Finding	64
Specifications.....	64
External Battery	64

IMPORTANT INFORMATION

- Do not connect relays to 110/230 V AC power.
- For indoor use only. A supplementary enclosure is required for outdoor use.
- The appliance is not intended for use by young children or infirm persons without supervision.
- Young children should be supervised to ensure that they do not play with the appliance.
- Refer servicing to a Gallagher Authorised Service Centre.
- Follow the energizer manufacturer's recommendations regarding earthing (grounding).
- Do not install an earth (ground) system for your electric fence within 10m (33 ft) of any power, telecommunications or other system.
- Use high voltage lead-out cable in buildings to effectively insulate from the earthed structural parts of the building and where soil could corrode exposed galvanised wire. Do not use household electrical cable.
- Connecting leads that are run underground must be run in conduit of insulating material or else insulated high voltage lead-out cable must be used. Care must be taken to avoid damage to the connecting leads due to the effects of animal hooves or tractor wheels sinking into the ground.

Note: Changes or modifications not expressly approved by Gallagher Limited could void the user's authority to operate this equipment.

i-SERIES ALARM SYSTEM

Kit Contents

- Alarm system
- 110V- 230V Mains AC adaptor
- RJ12 connection cable for i-Series operation
- Terminating resistors
- Adjustable nylon bushing
- 4 mounting screws
- Instruction manual



Optional Accessories

- 2M1134 12V 7AH sealed lead acid battery
- G56902 12V 120dB Siren
- G56901 12V Strobe Blue
- G56760 SMS Controller

Product overview

The Gallagher Alarm System creates a link between an electric fence energizer and a security system, which may include Siren alarms and/or Strobe lights. The system notifies you if the voltage on the fence drops to an insufficient level, due to fence faults or wire breakages.

The Gallagher Alarm system can be configured as below:

- Standard mode - can be used with any Energizer
- i-Series mode - if used in conjunction with a Gallagher i-Series energizer (up to six Alarm systems can be connected to a Gallagher i-Series energizer).

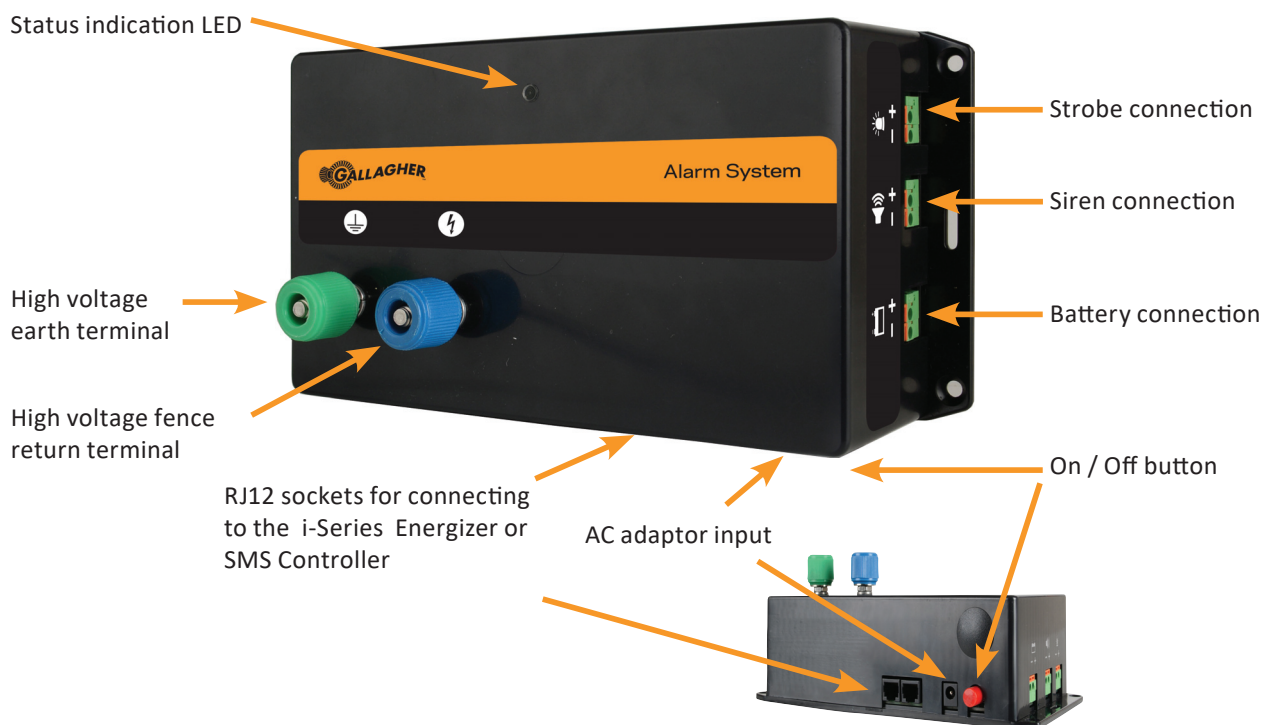

QUICK INSTALLATION GUIDE

The following steps show how to quickly get the Alarm system up and running.

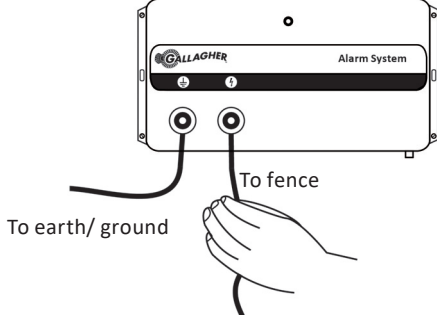
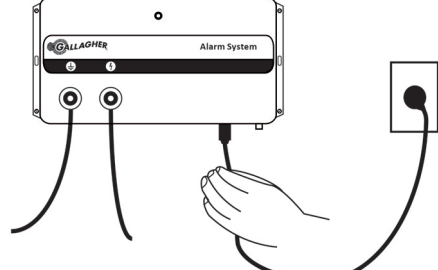
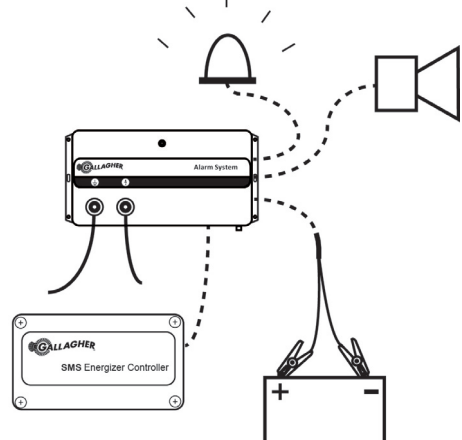
Step	Standard mode	i-Series mode
1	Set to standard mode. See <i>Zone Address Settings</i> (p. 59).	If zone 6 is already used in the existing i-Series system, then the Alarm system zone has to be set to any other available zone setting. See <i>Zone Address Settings</i> (p. 59)
2	Mount to the wall and connect the high voltage fence return and earth (ground) terminals.	
3	Connect to AC adaptor power supply	
4	Optional connections: <ul style="list-style-type: none"> • Via RJ12 cable to i-Series system, or to an SMS Energizer controller if in standard mode. • Relay 1 output to the Gallagher strobe light • Relay 2 output to the Gallagher siren • 12V battery 	
5	Turn the Energizer and Alarm System ON.	
6	Pressing the On/Off button arms/disarms the alarm.	

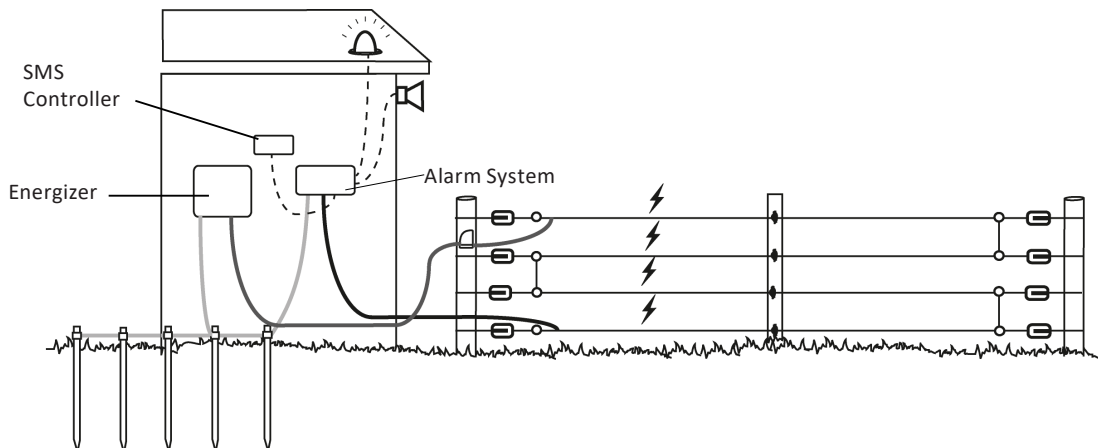

ADVANCED FEATURES

- Adjustable alarm levels
- External inputs for door and PIR sensors
- Adjustable alarm delay times
- Powered or Non-powered relay contacts
- SMS connection

Adjustable Settings

To alter the configuration of the Alarm System, remove from the wall and unscrew the 6 screws on the back of the unit.

To make changes to the alarm system settings, the alarm unit must have all power removed.

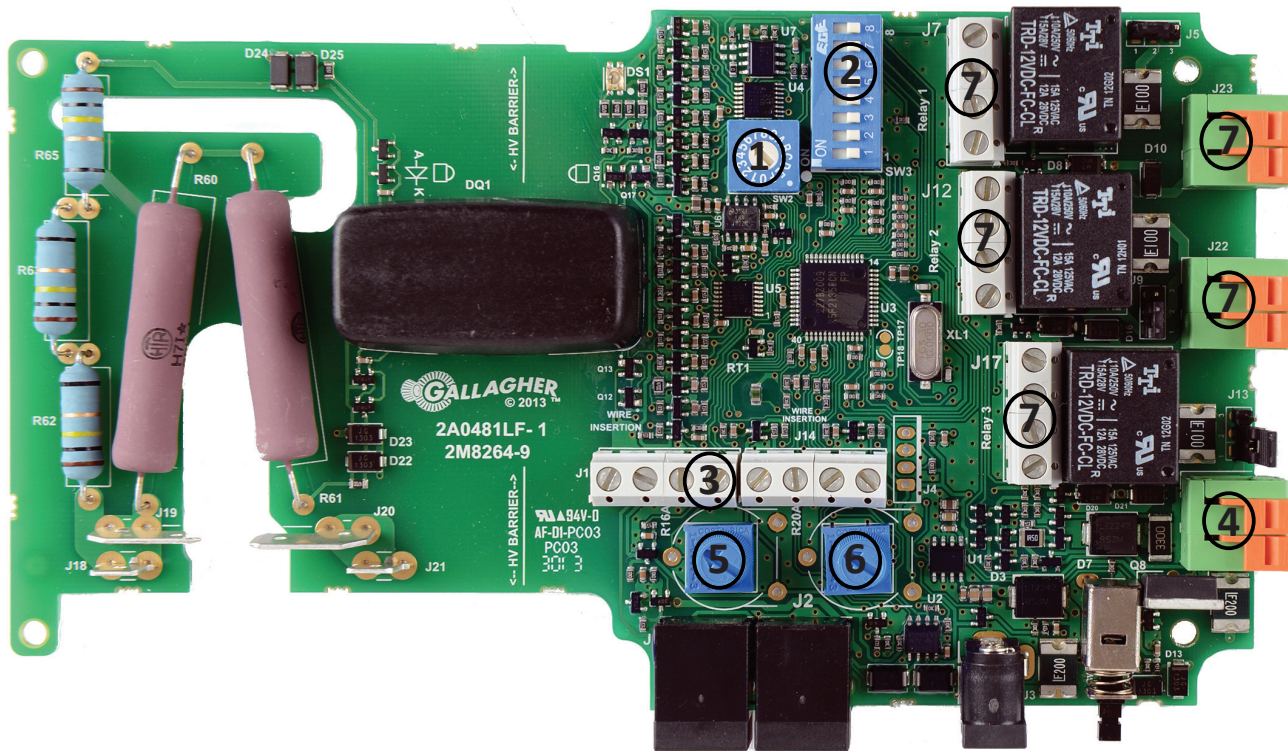

1	i-Series - Zone address selector Standard - Voltage alarm level
2	Functional settings
3	External Inputs
4	Battery connection
5	Alarm time
6	Delay time
7	Powered / Non-Powered relay contacts

1. Zone Address settings

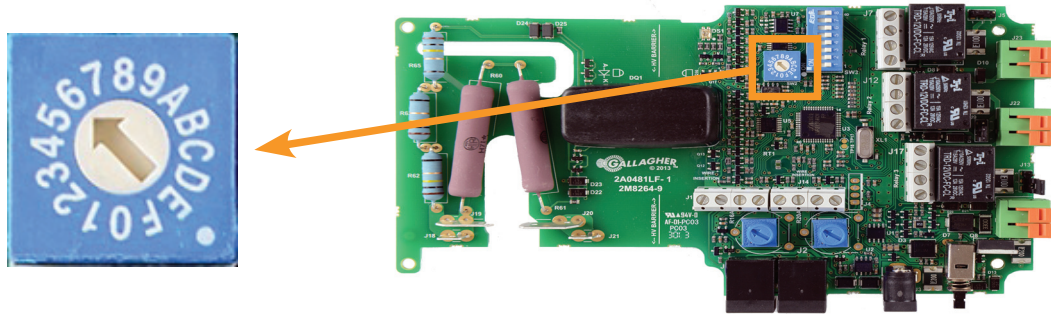

Address settings	Function - i series
1 - 6	Adjustable unit zone address (for use with Gallagher i-Series fence energizers). Default is 6.
	Function - standard mode
0	Fence alarm OFF
8	1kV fence alarm threshold
9	2kV fence alarm threshold
A	3kV fence alarm threshold
B	4kV fence alarm threshold
C	5kV fence alarm threshold
D	6kV fence alarm threshold
7	Unused
E, F	Unused

Note: To make changes to the alarm system settings, the alarm unit must have all power removed.

2. Functional settings

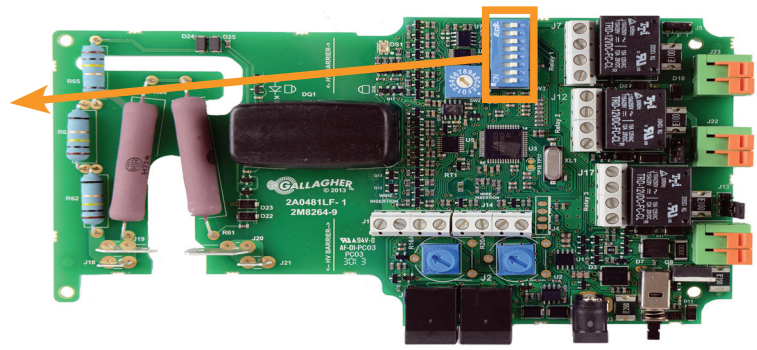

Switch	Setting	OFF (Default)	ON
1	Relay 1	Latched	Timed
2	Relay 2	Timed	Latched
3	Relay 3	Latched	Timed
4	Fence alarms	Local	Global
5	Unused		
6	Pulse monitoring	One pulse missed (i-Series mode)	15 seconds (i-Series and Standard mode)
		7 seconds (Standard mode)	
7	External inputs activate	Relay 3 only	All relays
8	External inputs activation mode	Switch input	Security (balanced) inputs

Setting relay 1,2,3

In a standard installation, relay 1 will be connected to a strobe light and relay 2 will be connected to a siren. Relay 3 is exclusively used for alarms associated with the external inputs.

The relays can be optionally timed or latched. When timed is selected, the ALARM TIME determines how long the relay is turned on for. Refer to *Alarm Time/ Delay Time* (p. 62) for further details. When latched is selected, the relays stay on until the reset button is pressed.

Fence alarms

In both modes of installation (i-Series or standard), the alarm system can be set to toggle only its relays under local settings (default) or have all connected alarm systems act upon the alarms when set to global.

Pulse monitoring

This sets the alarm delay time when operating in i-Series mode. The alarm can be set to trigger from either one pulse missed (default) or after 15 seconds.

In standard mode the alarm can be set to trigger after 7 seconds (default) or after 15 seconds. Refer to *Alarm Time/ Delay Time* (p. 62) for further details.

When in standard mode the delay time can be set by the delay time trimpot.

External inputs activate

External inputs such as a motion sensor or reed switch can be connected. An alarm condition will toggle only Relay 3 (default) OR Relay 1, Relay 2 and Relay 3 depending on the switch position.

External inputs activation mode

External inputs can be configured either as switch input where the alarm operates when the inputs are pulled to earth (ground), (a switch closes between one of the three inputs and earth (ground) that is J14 or J15 pin 2 and 4) or balanced inputs (standard security type that require 4k7 terminating resistors).

3. External Inputs

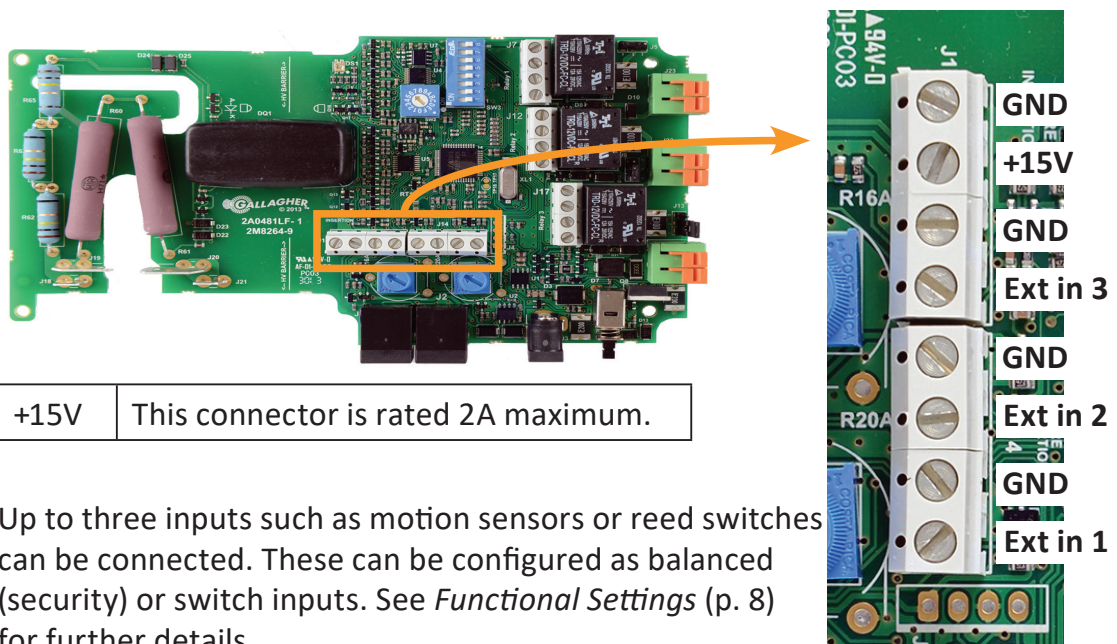

Up to three inputs such as motion sensors or reed switches can be connected. These can be configured as balanced (security) or switch inputs. See *Functional Settings* (p. 8) for further details.

The external inputs have an exit delay (10 sec to 3 mins) and entry delay (0 sec to 3 mins) to allow time to exit a secure room after arming the alarm and to disarm the alarm when entering a secure room.

Pressing the On/Off button arms/disarms the alarm.

4. ON / OFF

Depress the red button to turn the alarm system on.

Press again to turn the alarm system OFF.

While in an OFF position, battery charging continues.

5. Alarm time

The Alarm Time is the period of time that the alarm stays on for and can be set to between 10 seconds (default) and 12 minutes.

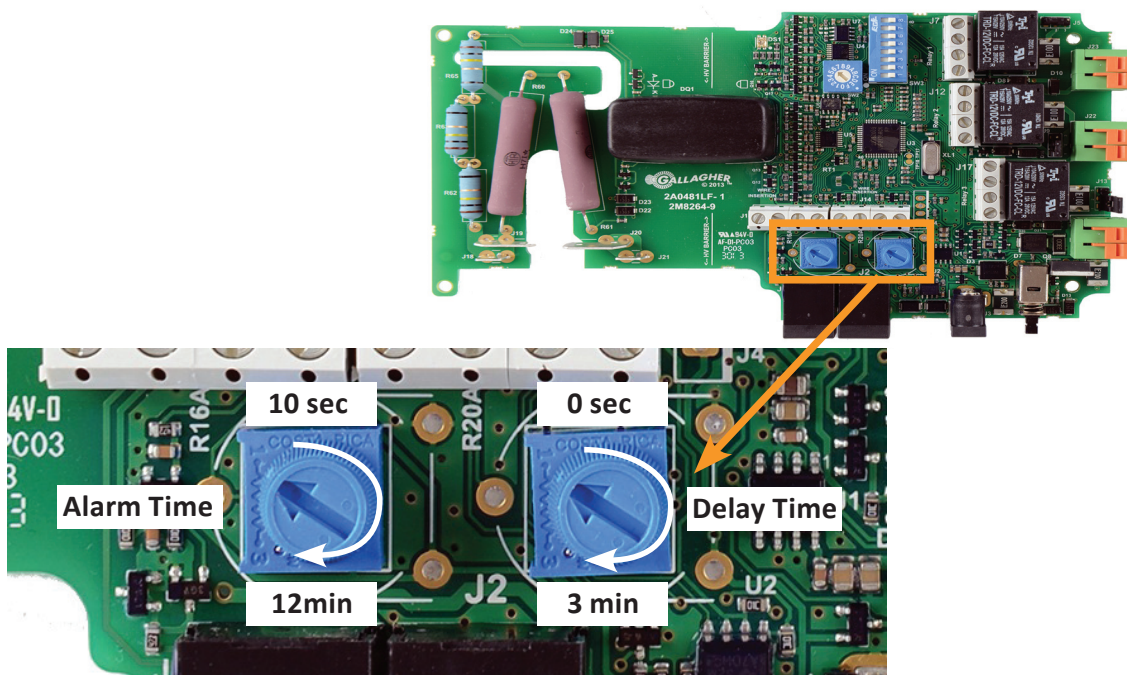

6. Delay time

The delay time can be set to any value between 0 seconds (default) and 3 minutes.

- For an exit delay: (10 sec - 3 mins)**
 The delay time starts when the on / off push button is depressed (on position). Alarms are only enabled after the delay time.
- For an entry delay: (0 sec - 3 mins)**
 When an alarm is detected, it will trigger the relay(s) after the delay time is over. To prevent this from happening, press the on/off push button before the delay time elapses.

7. Relays

The relays have a powered (12-15V DC) common (COM) by factory default. That is, connectors J5, J9, J13 have links between pin 1 and 2. The holder position for the linking bars, for an unpowered COM, is between pin 2 and 3.

The N/O (normally open) contact is used for the siren and strobe. When an alarm occurs the relay is energized and the contacts close.

Access to relay 3 contacts, used for external alarm inputs and N/C (normally closed) relay contacts, are by screw type connectors internal to the enclosure.

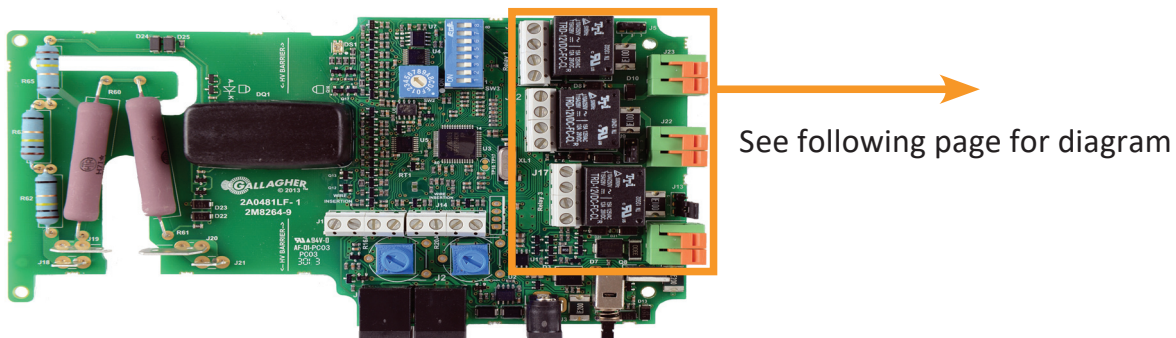

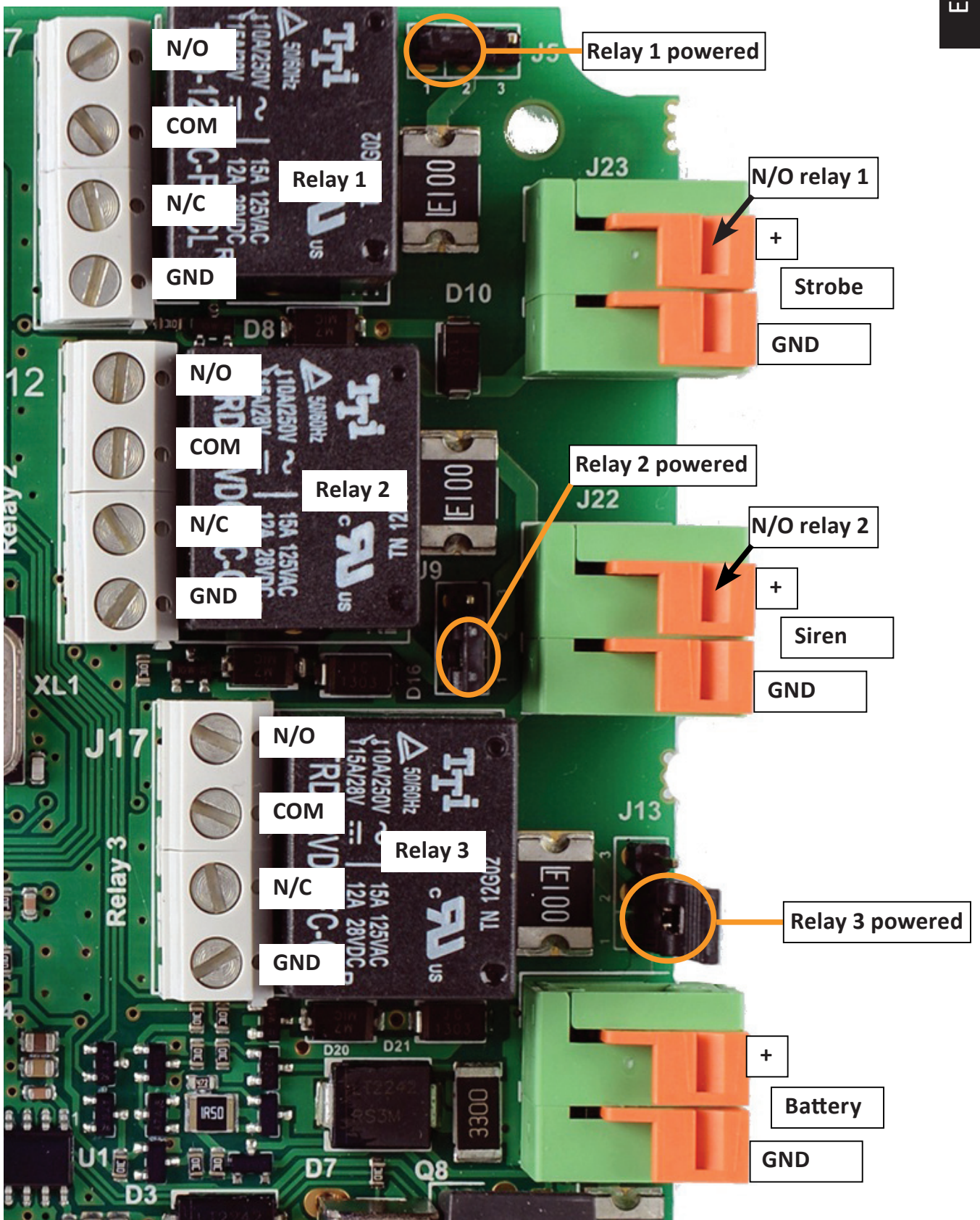

LED STATUS INDICATORS

LED state	Indicates
Green continuous	Alarm system set and either powered by the AC adapter or a fully charged battery.
Green flashing	Alarms are set, but there is no RJ12 connection to the energizer (i-Series mode only).
Orange continuous	Low battery (changes to red if alarm detected).
Orange flashing	Battery voltage above 18V.
Red continuous	Alarm detected, in alarm delay or in alarm.
Red flashing	Alarm Entry delay time elapsed for external inputs.

FAULT FINDING

Fault	Solution
SMS message EN: MAINS FAILURE	Check alarm system power supply.
SMS message EN: OA x.ykV!	Alarm system in voltage alarm.
SMS message EN: OA! x.ykV	One of the external inputs activated.
SMS message EN: ERROR	Energizer pulse is missed by the alarm system.

SPECIFICATIONS

	Min	Max
Input voltage DC (V)	10.8	15
Operating temperature (°C)	-10	50
Input Fence (kV)	0	10
Relay contact (V)	-	40
Supply Current	45mA	125mA
Standby Current	33mA	-

EXTERNAL BATTERY

Battery charging is optimized for a 12V 7 AH valve regulated lead acid battery. Other 12V lead acid batteries can be used.

Avoiding Battery Leakage	To avoid battery leakage, only used sealed, valve regulated (VRLA) or GEL type lead acid batteries.
Disposing the Battery	Batteries must be disposed of safely according to local regulations.