

WOOD CHIPPER

ASSEMBLY GUIDE



GS1500



GS150001



GS150002

Read this owner's manual carefully in its entirety before attempting to assemble this machine. Read, understand and follow all instructions on the machine before operation. Be completely familiar with the controls and the proper use of the machine before operating it. Keep this manual in a safe place for future and regular reference and for ordering replacement parts



This product picture is a schematic diagram, some details may not be exactly the same with the product you bought.

TABLE OF CONTENTS

SPECIFICATIONS	3
SECTION I: SAFETY	
GENERAL RULES	5
WARNING LABELS	6
TRAINING	8
PREPARATION	8
OPERATION	9
TOWING	11
MAINTENANCE & STORAGE	11
OPERATOR ZONE	13
YOUR RESPONSIBILITY	13
SAVE THESE INSTRUCTIONS FOR FUTURE REFERENCE	13
SECTION II: ASSEMBLY	
PACKAGE CONTENTS	16
UNPACKING AND CHECKING THE CONTENTS	16
WOOD CHIPPER ASSEMBLY	17
SECTION III: OPERATION	
PROPER USE GUIDELINES	20
OIL AND FUEL	21
STARTING AND STOPPING	22
OPERATION NOTES	23
SECTION IV: CHIPPING	
PROCESSING 12cm OR SMALLER TREES	25
CHIPPING NOTES	25
TROUBLESHOOTING	26
SECTION V: MAINTENANCE & STORAGE	
HOW TO MAINTAIN YOUR MACHINE	28
REMOVAL, SHARPENING & REINSTALLATION OF CHIPPER BLADE	29
ADJUSTING OR REPLACING BELT	30
CENTRIFUGAL CLUTCH TECH TIPS	31
TROUBLESHOOTING	33
PARTS DIAGRAM	35
PARTS LIST	36

SPECIFICATIONS

Item Number						
Engine	Ducar DH420	Loncin G420F(D)	Briggs & Stratton XR2100	Kohler CH440	Yamaha MX400	Honda GX390
Displacement	420cc	420cc	420cc	429cc	402cc	389cc
Net Power	15hp (9.1kw)	15hp (9.0kw)	13.5hp (9.0kw)	14hp(10.5kw)	12.8hp (9.4KW)	13hp (9.6kw)
Chipping Capacity	120mm (4.73")					
Weight	177kgs					
Length	2560mm					
Width	890mm					
Height	1480mm					
Operating RPM	3600 RPM					
Type of Fuel	Gasoline					
Starting Method	Recoil / E-start					
Wheel Tire	16*8.0-7 ATV Pneumatic Wheel					
Cutting Method	Drum					
Roller Diameter	233mm					
Blade Nos	2 x blade;1 x anvil					
Packaging	Wooden Crate					
Package Size	900x770x1230mm					
Gross Weight	200kgs					

SECTION I

SAFETY

SAFETY

GENERAL RULES



This symbol points out important safety instructions which, if not followed, could endanger the personal safety and/or property of yourself and others.

Read and follow all instructions in this manual before attempting to operate your chipper. Failure to comply with these instructions may result in personal injury.

When you see this symbol - heed its warning.

THIS MACHINE IS CAPABLE OF INFLICTING SERIOUS INJURY IF OPERATED IMPROPERLY - READ WARNINGS AND CAUTION LABELS.

INTENDED USE

Never use your chipper for any other purpose than chipping wood. It is designed for this use and any other use may cause serious injury and void the warranty.



DANGER: Rotating cutting blade.

Keep your hands and feet out of inlet and discharge opening while machine is running.



DANGER: This machine can **CRUSH, GRIND, CUT,** and **SEVER** parts of your body if they enter the inlet or discharge area of your chipper.



DANGER: Your chipper was built to be operated according to the rules for safe operation in this manual. As with any type of power equipment, carelessness or error on the part of the operator can result in serious injury. If you violate any of these rules, you may cause serious injury to yourself or others.

SAFETY

WARNING LABELS

MAKE CERTAIN THAT ALL SAFETY LABELS ON THIS EQUIPMENT ARE KEPT CLEAN AND IN GOOD CONDITION. IF YOU NEED REPLACEMENT LABELS, CONTACT THE SUPPLIER.

⚠ DANGER ⚠

- Read and understand the operator's manual before starting and using unit.
- Keep all shields and guards in place and securely attached.
- Keep hands, feet, face, clothing and long hair out of infeed bin, and discharge chute while the engine is running. Rotating cutting blades inside these openings can cause serious personal injury. Material being processed may bounce back from inlet openings or be thrown from the discharge chute. Long hair or loose clothing may be pulled or sucked into the inlet openings.
- If the chipper jams or becomes clogged, immediately shut off the engine and wait for all moving parts to come to a complete stop before clearing.
- If engine stalls because of a jam, move throttle control lever to stop position or shut off rocker to "0" if equipped before clearing.
- Do not install, remove, adjust, or service the discharge screen or any other part while the engine is running. Blade contact can occur.
- Do not operate on uneven ground where unit is unstable.
- To avoid a fire hazard, keep leaves, grass, and other combustible materials away from hot engine and muffler.
- Keep children and others away from area of operation.
- Wear approved safety glasses, gloves and ear protection.
- Do not operate on pavement, gravel or other hard surfaces since objects can ricochet and cause injury.

⚠ WARNING ⚠

DO NOT place wood or branches over 12 cm in diameter into the infeed bin. The blades may get stuck or jammed.

12 cm

Check belt tension before operating chipper. Belt deflection should be less than 1cm when 4.5kg. of pressure is applied to the belt. The belt will relax after the first 1-2 hours of use. You must re-check and adjust accordingly or the belts will begin to slip and wear. For best performance check for proper belt tension every 20 hours of use.

REPLACEMENT BELTS

⚠ DANGER ⚠

⚠ WARNING: EMERGENCY STOP

Make sure the emergency stop wire is connected correctly. Failure to do so may result in serious injury or death.

EMERGENCY SWITCH **EMERGENCY STOP WIRE**

⚠ WARNING: EMERGENCY STOP

GS1500/GS150001

GS150002

SAFETY

WARNING LABELS

MAKE CERTAIN THAT ALL SAFETY LABELS ON THIS EQUIPMENT ARE KEPT CLEAN AND IN GOOD CONDITION. IF YOU NEED REPLACEMENT LABELS, CONTACT THE SUPPLIER.

⚠ **DANGER** ⚠

- Read and understand the operator's manual before starting and using unit.
- Keep all shields and guards in place and securely attached.
- Keep hands, feet, face, clothing and long hair out of infeed bin, and discharge chute while the engine is running. Rotating cutting blades inside these openings can cause serious personal injury. Material being processed may bounce back from inlet openings or be thrown from the discharge chute. Long hair or loose clothing may be pulled or sucked into the inlet openings.
- If the chipper jams or becomes clogged, immediately shut off the engine and wait for all moving parts to come to a complete stop before clearing.
- If engine stalls because of a jam, move throttle control lever to stop position or shut off rocker to "0" if equipped before clearing.

- Do not install, remove, adjust, or service the discharge screen or any other part while the engine is running. Blade contact can occur.
- Do not operate on uneven ground where unit is unstable.
- To avoid a fire hazard, keep leaves, grass, and other combustible materials away from hot engine and muffler.

- Keep children and others away from area of operation.
- Wear approved safety glasses, gloves and ear protection.
- Do not operate on pavement, gravel or other hard surfaces since objects can ricochet and cause injury.

⚠ **WARNING** ⚠

DO NOT place wood or branches over 12cm in diameter into the infeed bin. The blades may get stuck or jammed.

12cm
MAX

4.5kg
MAX
1cm

Check belt tension before operating chipper. Belt deflection should be less than 1cm when 4.5kg . of pressure is applied to the belt. The belt will relax after the first 1-2 hours of use. You must re-check and adjust accordingly or the belts will begin to slip and wear. For best performance check for proper belt tension every 20 hours of use.

REPLACEMENT BELTS

⚠ **DANGER** ⚠

⚠ **DANGER** ⚠

⚠ **DANGER** ⚠

⚠ **DANGER** ⚠

⚠ **WARNING: EMERGENCY STOP**

Make sure the emergency stop wire is connected correctly. Failure to do so may result in serious injury or death.

⚠ **WARNING: EMERGENCY STO**

GS1500/GS150001

GS150002

SAFETY

SAFE OPERATION PRACTICES

TRAINING

- Read this owner's manual carefully in its entirety before attempting to assemble this machine. Read, understand and follow all instructions on the machine before operation. Be completely familiar with the controls and the proper use of the machine before operating it. Keep this manual in a safe place for future and regular reference and for ordering replacement parts.
- Never allow children to operate the unit. Never operate the equipment without proper instruction. Only responsible individuals who are familiar with these rules of safe operation should be allowed to use this unit.
- Keep the area of operation clear of all persons, particularly small children and pets. Stop the engine when they are in the vicinity of the unit. Keep work area clean and clear of branches and obstacles, which could cause you to stumble or fall.
- Keep in mind that the operator or user is responsible for accidents or hazards occurring to other people, their property, and themselves.
- Your chipper is a powerful tool, not a plaything. Exercise extreme caution at all times. Your unit has been designed to chip wood. Do not use it for any other purpose.
- If situations occur which are not covered in this manual, use care and good judgment.

PREPARATION

- Thoroughly inspect the area where the equipment is to be used and remove all foreign objects.
- Do not operate the machine without wearing adequate protection and safety goggles. Always wear safety glasses or goggles during operation and while performing any adjustment or repair, to protect eyes from foreign objects that may be thrown from the machine. Be sure your glasses or goggles fit properly.
- Avoid loose-fitting clothes and use protective footwear that will improve footing on slippery surfaces. Shirt and slacks that cover the arms and legs and steel-toed boots are recommended. Secure hair above shoulders. Do not wear loose clothes or jewelry that can be caught in moving parts. Never operate the unit in bare feet, sandals, or sneakers. Wear gloves when feeding the material into the chipper chute. Be sure your gloves fit properly.



WARNING: Fuel is highly flammable and the vapors are explosive. Take the following precautions.

- Store fuel and oil in approved containers.
- Keep away from heat and open flame, and out of reach from children.
- Refuel outdoors only and do not smoke while refueling.

SAFETY

SAFE OPERATION PRACTICES

- Check and add fuel before starting the engine. Never remove gas cap or add fuel while the engine is running or when the engine is hot. Allow engine to cool before refueling.
- If fuel is spilled, do not attempt to start the engine but move the machine away from the area of spillage and avoid creating any source of ignition until fuel vapors have disappeared.
- Replace all fuel tank and container caps securely.
- Never store the machine or fuel container inside where there is an open flame or spark, such as a gas hot water heater, space heater, clothes dryer or furnace.
- To reduce fire hazard, keep engine and muffler free of debris build-up. Clean up fuel and oil spillage. Allow unit to cool at least five minutes before storing.
- Never attempt to make any adjustments while the engine is running.

OPERATION

- Never place your hands, feet, or any part of your body in the chipper chute, discharge opening, or near or under any moving part while the engine is running. Keep clear of the discharge opening at all times. If it becomes necessary to push material into the chipper chute, use a small diameter stick, **NOT YOUR HANDS**.
- Keep your face and body back from chipper chute to avoid accidental bounce back of any material.
- The machine should only be operated on a level surface. Never operate your unit on a slippery, wet, muddy, or icy surface.
- Stay alert for hidden hazards or traffic. Do not carry passengers.
- If the cutting mechanism strikes a foreign object or if your machine should start making an unusual noise or vibration, immediately stop the engine, After the machine has come to a complete stop proceed as follows:
- Remove the spark plug wire(s) and wait for all moving parts to come to a complete stop.
 - Inspect for any damage
 - Repair or replace any damaged parts before restarting and operating the machine.
- Exercise caution to avoid slipping or falling
- If the machine should start to vibrate abnormally, immediately stop the engine, and wait for all moving parts to come to a complete stop and inspect for the cause. Vibration is generally a warning sign of trouble.
- Stop the engine when leaving the operating position, and when making any repairs, adjustments and inspections. **STAY CLEAR OF THE CHIP CHUTE AT ALL TIMES.**
- Take all possible precautions as recommended by the manufacturer when leaving the machine unattended. Push the E-STOP.
- Before cleaning, repairing, or inspecting, shut off the engine and make certain the flywheel and all moving parts have come to a complete stop. Disconnect the spark plug wire and keep the wire away from spark plug to prevent accidental starting.
- Never run this machine in an enclosed area as the exhaust from the engine contains carbon monoxide, which is an odorless, tasteless, and deadly poisonous gas.

SAFETY

SAFE OPERATION PRACTICES

- Keep all guards and safety devices in place and operating properly. Do not operate the machine if all safety guards are not in place.
- Do not use the unit with the chipper hopper removed.
- The muffler and engine become hot and can cause a severe burn. Do not touch.
- Keep children and pets away.
 - Tragic accidents can occur if the operator is not alert to the presence of small children.
 - Keep children out of the work area and under the watchful eye of a responsible adult other than the operator.
 - Be alert and turn the unit off if a child enters the area.
 - Never allow children to operate the chipper.
- Do not overload or attempt to chip material beyond 4 inches.
Personal injury or damage to the machine could result.
- Never operate the machine at high transport speeds or on hard or slippery surfaces.
- Never allow bystanders near the unit while running.
- Only use accessories approved for this machine by the manufacturer. Read, understand, and follow all the instructions provided with the approved accessory.
- Only operate unit in good daylight. Do not operate unit at night or in dark areas where your vision may be impaired.
- Use extreme caution when reversing or pulling the machine towards you. NEVER move the machine while it is running.
- Do not tamper with the engine's governor setting. The governor controls the maximum safe operation speed and protects the engine. Over-speeding the engine is dangerous and will cause damage to the engine and to the other moving parts of the machine.
- Start the engine according to the manufacturers instructions. Keep hands and feet away from inlet and discharge areas.
- Never pick up or carry the machine while the engine is running.
- Do not operate while under the use of alcohol, drugs, or medication. A clear mind is essential for safety.
- Do not allow anyone who is not alert to operate this machine.
- When feeding material into this equipment, be extremely careful that pieces of metal, rocks, or other foreign objects are not included. Personal injury or damage to the machine could result.
- Keep area of discharge clear of people, animals, buildings, glass or anything else that will obstruct clear discharge, cause injury or damage. Wind can also change discharge direction, so be aware.
- Do not allow an accumulation of processed material to build up in the discharge area as this will prevent proper discharge and can result in kick-back from the chipper chute.
- Do not allow any part of the engine, especially around the cooling fins and muffler, to become clogged with processed material, leaves, oil, grease or any other combustible material.
- Do not operate engine if air cleaner or cover over carburetor air-intake is removed, except for adjustment. Non-Removal of such parts could create a fire hazard.

SAFETY

SAFE OPERATION PRACTICES

TOWING

- Obey all state and local regulations when towing on public roads. **THIS MACHINE IS NOT HIGHWAY TOWABLE.**
- Before towing, be certain the chipper is correctly and securely attached to the towing vehicle and the safety chains are in place. Leave slack in the chains to allow for turning.
- Do not allow anyone to sit or ride on the chipper. This can cause serious injury.
- Stay alert for hidden hazards or traffic. Do not carry passengers.
- Never carry any cargo or wood on your chipper. It may fall off and endanger following vehicles.
- Allow for added length when turning, parking, crossing intersections and in all driving situations.
- Be careful when backing up. You can easily jackknife your chipper.
- Adjust towing speed for terrain and conditions. Do not exceed 45 MPH when towing.
- Because there is no suspension on the chipper, it will tend to bounce more on rough roads. Be extra cautious when towing over bumpy or rough terrain including railroad crossings.

MAINTENANCE & STORAGE

- Keep machine, attachments and accessories in safe working condition.
- Check engine mounting bolts and other hardware before each use for proper tightness. Never operate your chipper in poor mechanical condition or when in need of repair. Be sure all safety guards and shields are in proper position. These safety devices are for your protection.
- Never store machine with fuel in the fuel tank inside a building where ignition sources are present, such as hot water and space heaters, clothes dryers and the like. Allow the engine to cool before storing in any enclosure.
- Always refer to the operator's manual for important details if the machine is to be stored for an extended period.
- If the fuel tank is to be drained, do this outdoors.
- If it is necessary for any reason to unclog the feed intake or discharge openings or to inspect or repair the machine where a moving part can come in contact with your body or clothing, shut the machine off, allow all moving parts to come to a complete stop, disconnect the spark plug wire(s) and allow the engine to cool before attempting to unclog, inspect or repair.
- Check the blade mounting screws before each use for proper tightness. Also visually inspect the blade for wear or damage. Replace the blade with parts that meet original equipment specifications.

SAFETY

SAFE OPERATION PRACTICES

- Blades should be checked for sharpness and the bolts attaching them to the drum for tightness before each operation.
- Replace the nylock nuts securing the blade every time you replace the blade.
- Check the gap between the blade and wear plate every time you sharpen or replace the blade.
- Never tamper with safety devices. Check their proper operation regularly.
- Inspect the belt each time you use the unit. Look for damage, worn areas or tears. Do not use the unit if this condition exists.
- Do not tamper with the engine's governor setting. The governor controls the maximum safe operation speed and protects the engine. Over-speeding the engine is dangerous and will cause damage to the engine and to the other moving parts of the machine.

SAFETY

SAFE OPERATION PRACTICES

OPERATOR ZONE

- Only operate your chipper from the operator zone.
- Know how to turn your unit off.
- Never move your chipper or leave it unattended with the engine running.
- Follow engine owner's manual for engine maintenance and repair

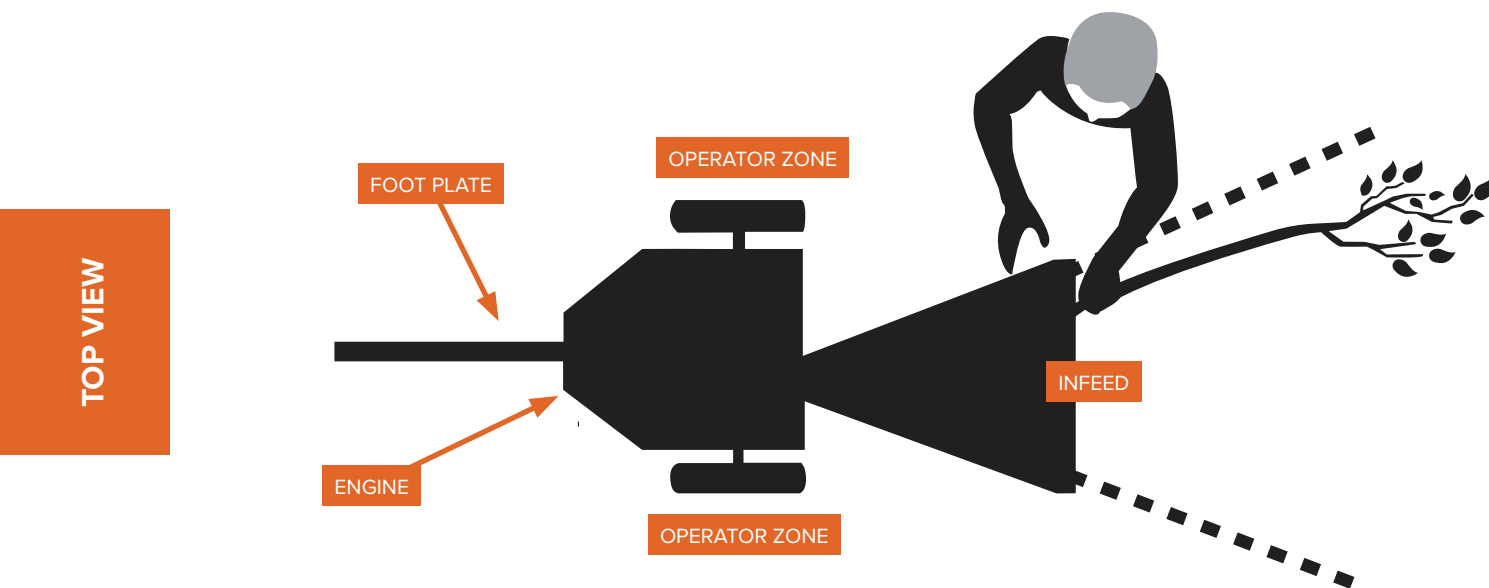

HAZARD: This unit is equipped with an internal combustion engine and should not be used on or near any unimproved forest-covered, brush-covered or grass-covered land unless the engine's exhaust system is equipped with a spark arrester applicable to local or state laws (if any). If a spark is used, the operator should maintain it in effective meeting arrester working order.

YOUR RESPONSIBILITY

- Restrict the use of this power machine to persons who read, understand and follow the warnings and instructions in this manual and on the machine.

SAVE THESE INSTRUCTIONS FOR FUTURE REFERENCE

SECTION II

ASSEMBLY

ASSEMBLY

PACKAGE CONTENTS

LIST	QUANTITY
Wood chipper	1 pc
T- shape wrench	1 pc
Flat wrench	1 pc

UNPACKING AND CHECKING THE CONTENTS

- Remove all the items from the crate.
- After unpacking the crate, compare the contents with the list above.
- If any parts are missing, please contact the supplier directly.
- Assembly should be done on a clean, level surface.

ASSEMBLY

STEP BY STEP INSTRUCTIONS

Set the shipping crate on a solid flat surface and carefully remove the lid. Use two people and take all parts out of the crate and inspect the components to ensure there are no missing pieces before starting to assemble the wood chipper.

1. WHEELS

Push the axis through the rim, tighten the nut and secure with a splint. Then fit the hubcap.

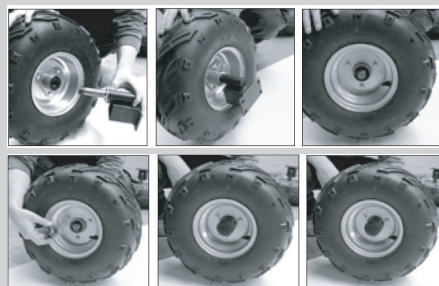

Axis: Tilt the blades chassis slightly backwards and fix the axis with screws, washers and nuts.

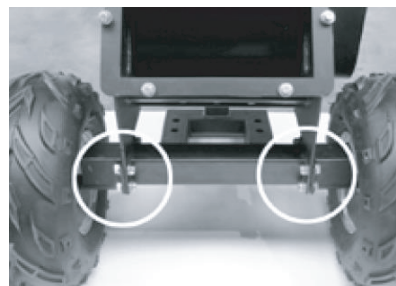

2. BASE FOOT

Tilt the blades chassis slightly backwards and fix the base foot with screws, washers and nuts.

Drawbar:
Place the drawbar on the base foot and fix with screws M12x100, washers and nuts M12.

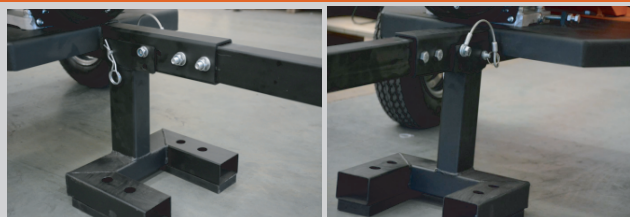

ASSEMBLY

STEP BY STEP INSTRUCTIONS

3. Install the discharge chute

Discharge chute:

Place the discharge chute on the blades chassis so that the mounting holes coincide with the holes on the discharge chute. Fix with screws, washers and

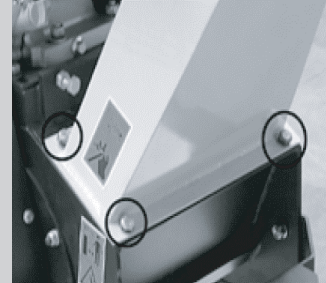

4. Install the feeding chute

In-feed:

Place the in-feed on the blades chassis so that the mounting holes coincide with the holes on the in-feed. Fix with washers and nuts.



5. Connect the emergency line and engine line

Safety switch:

Connect emergency line and engine line



SECTION III

OPERATION

OPERATION

PROPER USE GUIDELINES

BEFORE STARTING ENGINE, ALWAYS CHECK OIL LEVEL!

REFER TO THE ENGINE OWNER'S MANUAL FOR FURTHER DETAILS REGARDING OPERATION AND MAINTENANCE OF THE ENGINE.

NOTE: Engine is shipped without oil! Fill the crankcase with 10w30 oil before starting the engine. Be very careful not to allow dirt to enter the engine when checking or adding oil or fuel.

OIL

- Use a high quality oil per the gasoline engine Manual.
- Do not use special additives.

OPERATION

PROPER USE GUIDELINES

CHECKING AND ADDING OIL

- Check oil level before starting engine.
- Check oil level daily, or after every eight hours.
- Keep oil level at FULL.
- Do not overfill.

OIL FILLING PROCEDURE

Please follow your engine manual for instructions on filling the oil in your machine.

OIL CHECKING PROCEDURE

1. Before starting engine, check oil level.
2. Place engine level. Clean around oil fill and dipstick.
3. Push dipstick back in and remove to check oil level.
4. Remove oil fill cap. Pour oil slowly.
5. Fill to FULL mark on dipstick - re-check
6. Replace dipstick firmly.

FUEL

- Use clean, fresh, regular unleaded gasoline as per the engine manual.

ADDING FUEL

- Fill tank outdoors or in a well-ventilated area, away from sparks, open flames, pilot lights, heat and other ignition sources.
- If fuel spills, wait until it evaporates before starting engine.
- Turn engine OFF and let engine cool at least 2 minutes before removing gas cap.
- Remove cap. Fill tank to approximately 38mm below top of neck to allow for fuel expansion. Be careful not to overfill. Replace cap before starting.

OPERATION

PROPER USE GUIDELINES

STARTING AND STOPPING

STARTING AND OPERATING TIPS

- Store and fuel equipment in a level position.
- Use fresh fuel.
- Use correct type of oil as per your engine manual.
- Remove external equipment/engine loads.
- Periodically remove any debris build-up from the machine.
- After engine has started, let it warm up several seconds to several minutes, depending on outside temperature.
- For maximum performance and life, operate the engine with choke in RUN and throttle in FAST.

TO START ENGINE

- Check oil level.
- Open fuel shut-off valve.
- Move choke control to CHOKe position.
- Move throttle to TURTLE position. Operate engine with throttle in RABBIT.
- Let engine warm up. Slowly adjust choke control toward RUN position. Wait until engine runs smoothly before each choke adjustment.

TO STOP ENGINE

- Move throttle to TURTLE.
- Move gas lever to the far left.
- See engine manual for instruction.



CAUTION: Do not stop engine by moving choke control to CHOKe. Backfire, fire or engine damage could occur.

OPERATION

PROPER USE GUIDELINES

OPERATION NOTES

- At engine start-up, the engine of your chipper operates under no load at 3600 RPM until approximately 1200 - 1400 RPM's at which speed the centrifugal clutch engages and begins driving the rotor.
- Rotor speed is 2400 RPM + / - 200 RPM when engine is at full RPM.
- When viewed from the operator zone, the flywheel turns in a clockwise direction. This rotation pulls branches into the chipper.
- Always wear protective gloves and safety glasses during operation of the chipper.
- If it becomes necessary to push material into the chipper hopper, only use a wood stick, never your hands or anything steel.
- Always keep your hands out of the chipper hopper.
- Keep area of discharge clear of people, animals, buildings, glass or anything else that will obstruct clear discharge, cause injury or damage. Wind can also change discharge direction, so be aware.



PLEASE READ ALL SAFETY GUIDELINES IN THIS MANUAL PRIOR TO OPERATION.

SECTION IV

CHIPPING

CHIPPING

IMPORTANT NOTES

THIS CHIPPER WAS DESIGNED FOR CHIPPING 12cm(5") DIAMETER AND SMALLER TREES AND BRANCHES. NEVER USE THIS MACHINE FOR ANY OTHER PURPOSE AS IT COULD CAUSE SERIOUS INJURY.

PROCESSING 12cm(5") OR SMALLER TREES & BRANCHES

- Your chipper can process dry or green material.
- Feed branch into chipper hopper.
- Keep branch at same angle as chipper hopper.
- As the branch becomes short and is inside the chipper hopper, finish processing it by pushing it into the chipper with the next branch if needed.
- If branches are 5cm(2") or larger in diameter, feed only one branch at a time into the chipper.
- If branches are smaller than 5cm, more than one at a time can be fed into the chipper.
- Green branches process easier than hard wood.
- Make sure protective gloves are worn when feeding the chipper.

CHIPPING NOTES

- Use common sense when using your chipper.
- Learn to recognize the change in the sound of your machine when it is overloaded.
- Become familiar with successful operating conditions and avoid those that can overload and damage the machine.
- If the machine becomes jammed by overloading or any other cause, stop the machine immediately.
- If you jam the machine and do not stop the engine it can:
 - Burn the belt
 - Ruin the clutch

THIS DAMAGE CAN BE COSTLY AND IT IS NOT COVERED UNDER WARRANTY. FOR THIS REASON, IT IS IMPORTANT THAT YOU IMMEDIATELY SHUT OFF THE MACHINE IF IT BECOMES JAMMED.

- Only your operator experience will tell you how fast to feed trees and branches.
- Check to see that the flywheel will turn freely before you start the chipper.
- Visually check the chipper blade for damage each time you use your chipper.
- Check blade condition, wear plate condition, and the nuts and bolts that hold the blade in place for tightness before each use.
- To move pile of processed material, use a spade, rake, or long handle tool. Never use your hands or feet.

CHIPPING

TROUBLESHOOTING

FREEING A JAMMED DRUM

1. Stop the engine.
2. Remove the spark plug wire and keep away from spark plug.
3. Remove any material left in the chipper hopper.
4. Use a wrench to turn the drum shaft, first clockwise, then counter clockwise, until the jam is cleared. See picture below.
5. Remove the deflector.

NOTE: Never pry against the scroll weldment when removing the deflector or at any other time. This will cause damage to the machine.

6. Check to see if deflector is clogged. If it is, clear with a branch.
7. With a wooden stick, loosen and remove any material left in the chipping chamber.
8. Reinstall the deflector.
9. Reconnect the spark plug wire and battery (if so equipped).
10. Start the machine and let material in chipping chamber discharge through deflector.
11. If chamber doesn't clear and the drum is still jammed, repeat above process.
12. Be certain chipping chamber is clear before trying to process more material into the chipper.

SECTION V
MAINTENANCE & STORAGE

MAINTENANCE & STORAGE

HOW TO MAINTAIN YOUR MACHINE



IMPORTANT: The blade should be checked for sharpness and the nuts and bolts attaching them to the flywheel for tightness before each operation.



IMPORTANT: Every time you perform maintenance or any kind of service or check on the blade, be sure to check the gap between the blade and wear plate for proper setting.

If the cutting mechanism strikes any foreign object or if your machine should start making an unusual noise or is vibrating, stop the engine, disconnect the spark plug wires from the spark plugs. Allow the engine to cool before you:

- Inspect and examine for obvious damage.
 - Check for loose parts, bolts and nuts.
1. When not in use, your chipper should be stored out of reach of children. Be sure there is no gasoline fumes in the storage area. For long periods of storage (over winter), refer to the engine owner's manual.
 2. After every 8 hours of operation, lubricate the chipper side and drive side bearings. To do this, wipe all dirt, etc., from the grease fittings with a clean cloth, then apply no more than 3 shots of quality general-purpose grease with a hand-pumped grease gun. Over lubrication can also damage bearings. Also, check the bearing collar set screws regularly to be sure they are tight. If they are loose, reset them with Loctite, obtainable at any hardware store.
 3. You will find information included referring to operation and maintenance of the chipper engine.
 4. When the steel chipping knife needs replacing or sharpening, refer to the section on removal, sharpening and re-installation.
 5. When you install the new OEM blade, the clearance between the blade and anvil plate must be checked and set. This clearance or gap should be set to 1.58mm .
 6. To adjust this clearance, loosen the three nuts and bolts holding the wear plate in place. The anvil plate can be slid up or down (in or out) to achieve the correct gap setting.
 7. If the gap between the wear plate and the blade is not set correctly, you will have excessive vibration when chipping and the blade will seem to be dull. This should be checked every 8-10 hours of operation.

MAINTENANCE & STORAGE

REMOVAL, SHARPENING & REINSTALLATION OF CHIPPER BLADE

HOW TO REMOVE THE KNIFE

ATTENTION! Always wear safety gloves when working with blades. This machine is equipped with two reversible blades. When they lose their edge the blades can be turned to use the second edge. When the second edge is spent they have to be replaced. If you notice an increase in vibration it could be due to the cutting edges being worn, you will also notice that your cut material is in long strips when the blades are dull or worn.

REPLACEMENT OF THE ANVIL

The Anvil is also reversible. When the edge of the Anvil is worn it can be rotated. When both edges are worn, the Anvil must be replaced. The space between the blade and the anvil should always be 1mm.

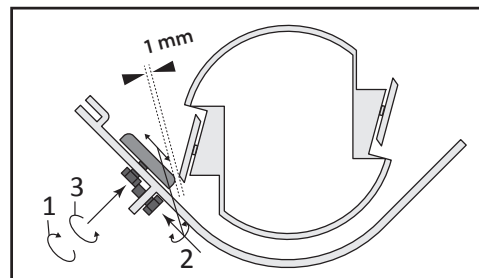
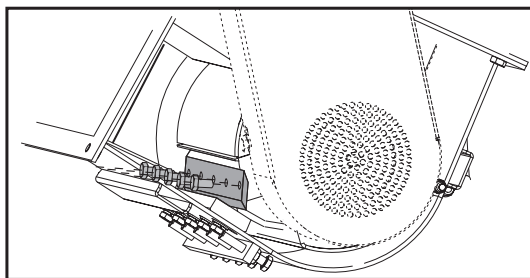

BLADE SHARPENING

- You should never attempt to sharpen the chipper blade.
- It is extremely important that the 45 degree angle be maintained consistently for proper performance.
- The chipper blade should be taken to a machine shop for proper sharpening.
- Excessive heat generated during the sharpening process will damage blades and weaken the metal.

MAINTENANCE & STORAGE

ADJUSTING OR REPLACING BELT

BELT ADJUSTMENT

The belt on your chipper should deflect 9mm (3/8") under three pounds of pressure as shown below. If it doesn't, adjust per the following directions

1. Remove belt guard.
2. Loosen the 4 engine plate bolts.
3. Move the motor with the horizontal adjustment bolts until you have the correct tension as shown below.
4. Retighten engine bolts.
5. Replace belt guard.

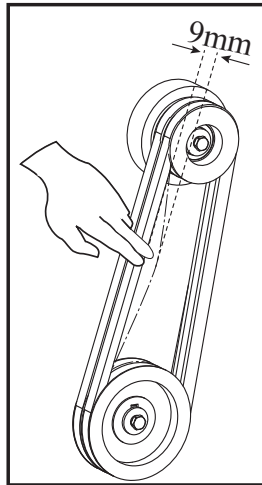

BELT REPLACEMENT

1. To replace the belt, follow the above belt adjustment directions.
2. After you have loosened the engine bolts, remove the old belts and replace it with new belts. Always replace both belts as they come in a matched set. This is required for proper operation.
3. Set belt tension and alignment per above instructions.

NOTE: Check and re-tighten belts after initial break-in period, one hour of use.

MAINTENANCE & STORAGE

CENTRIFUGAL CLUTCH TECH TIPS

THE SHOES AND SPRINGS ON THE CLUTCH ARE NORMAL WEAR ITEMS. IF YOU NOTICE DECREASED PERFORMANCE OF THE CLUTCH THEY SHOULD BE CHECKED AND REPLACED IF NECESSARY.

The clutch on your machine is designed for rugged, dependable service, however, it is important to understand the limitations of a clutch. A clutch is designed to provide load free starting of the engine, and slippage under excessive overloading of the driven application. These features help protect the engine from damages such as broken crankshafts and starters.

The clutch obtains its power from engine RPM's. The lower the engagement speed, and the higher the maintained engine speed, the more torque the clutch can transfer to the driven unit. Do not operate at less than full RPM's.

- At engine start-up, the engine of your chipper operates under no load until approximately 1000-1200 RPM'S at which speed the centrifugal clutch engages and begins driving the rotor.
- Proper rotor speed is 2400 RPM + / - 200 RPM when engine is at full RPM.
- Do not tamper with the engine's governor setting. The governor controls the maximum safe operation speed and protects the engine. Over-speeding the engine is dangerous and will cause damage to the engine and to the other moving parts of the machine. See your authorized dealer for engine governor adjustments.
- Become familiar with successful operating conditions and avoid those that can overload and damage the machine.
- Do not overload or attempt to chip material beyond manufacturers recommendation. Personal injury or damage to the machine could result.
- Learn to recognize the sound of the machine when it is overloaded.
- If the machine becomes jammed by overloading or any other cause, stop the machine immediately.
- If you jam the machine and do not stop the engine, it can:
 - Burn the belt.
 - Ruin the clutch.
- Only your operator experience will tell you how fast you can successfully feed limbs into the machine.
- Clutch damage can be costly and damage is not covered under warranty. For this reason, it is important that you immediately shut off the machine if it becomes jammed.

MAINTENANCE & STORAGE

CENTRIFUGAL CLUTCH TECH TIPS

CLUTCH MAINTENANCE

The centrifugal clutch on this machine is permanently lubricated and does not require oil or grease. If, after long periods of use, the drum wobbles excessively, replace the drum assembly. Always replace shoes and springs in sets. Whenever shoes are changed, replace all springs.

CLUTCH REMOVAL

1. Remove clutch from shaft by removing bolt and washers.
2. Slide clutch off shaft.
3. Remove key from keyway.

INSTALLATION OF A NEW CLUTCH

1. Clean shaft and remove any burrs.
2. Apply anti-seize compound to the shaft.
3. Place key in keyway on shaft.
4. Slide clutch onto shaft, secure with bolt, flatwasher and lockwasher.
5. Tighten two allen head set screws.

MAINTENANCE & STORAGE

TROUBLESHOOTING

Depending on the symptoms that you notice, you can discover the probable cause and solve the problem.

SYMPTOM	PROBLEM	CORRECTION
The machine does not work properly	The blades are blunt	Sharpen or replace the blades
The rotor does not suction the wood	The diameter of the branches is too big	Remove the branches with a diameter wider than that permitted.
The shredded material does not have the same thickness	The space between the blades is not correct	Adjust the space to 1 mm.
The engine does not start or it stops by itself	Engine electric problem	Avoid the accidental start up of the machine. Verify that the switch is in the ON "I" position. Make sure that the SC System is set to ON.
	No petrol left	Add fuel
	There is no engine oil or is low	Add oi
The machine gets stuck during use.	The diameter of the branch is too large	Turn off the engine and remove the spark plug. Remove the cap of the rotor shaft. Turn the rotor a few degrees with a wrench specifically designed for this purpose.
The engine does not start because of the rotor is stuck	Impeller or blades have woody residue or chunks stuck to them	Leave the rotor blocked using the key. Remove the material from the inlet tube with the help of a stick or a tool and restart the machine. If necessary, change the blades.

MAINTENANCE & STORAGE

TROUBLESHOOTING

If the machine does not start, check the compression of the engine and the spark from the spark plug:

The cylinder's compression is normal	The spark plug is OK	Probable Cause	Corrective Action
YES	YES	No fuel in the tank	Fill fuel tank with fuel
		The gasoline filter is dirty	Clean the filter
		There is water in the fuel	Replace fuel
		The gasoline used is not the right kind	Change the fuel with one with proper octane
		The carburetor is dirty	Send your machine to the service technician
YES	NO	The switch is "O"	Turn the switch to "I"
		The spark plug is dirty	Clean the spark plug
		The spark plug pipe is not connected	Connect the spark plug
No compression	YES	The spark plug is loose	Tighten the spark plug
		The piston and its segments are worn	Send your machine to the service technician
		The cylinder is scratched	Send your machine to the service technician
The engine does not turn		Cold engine	Send your machine to the service technician

MAINTENANCE & STORAGE

PARTS DIAGRAM (GS150002)

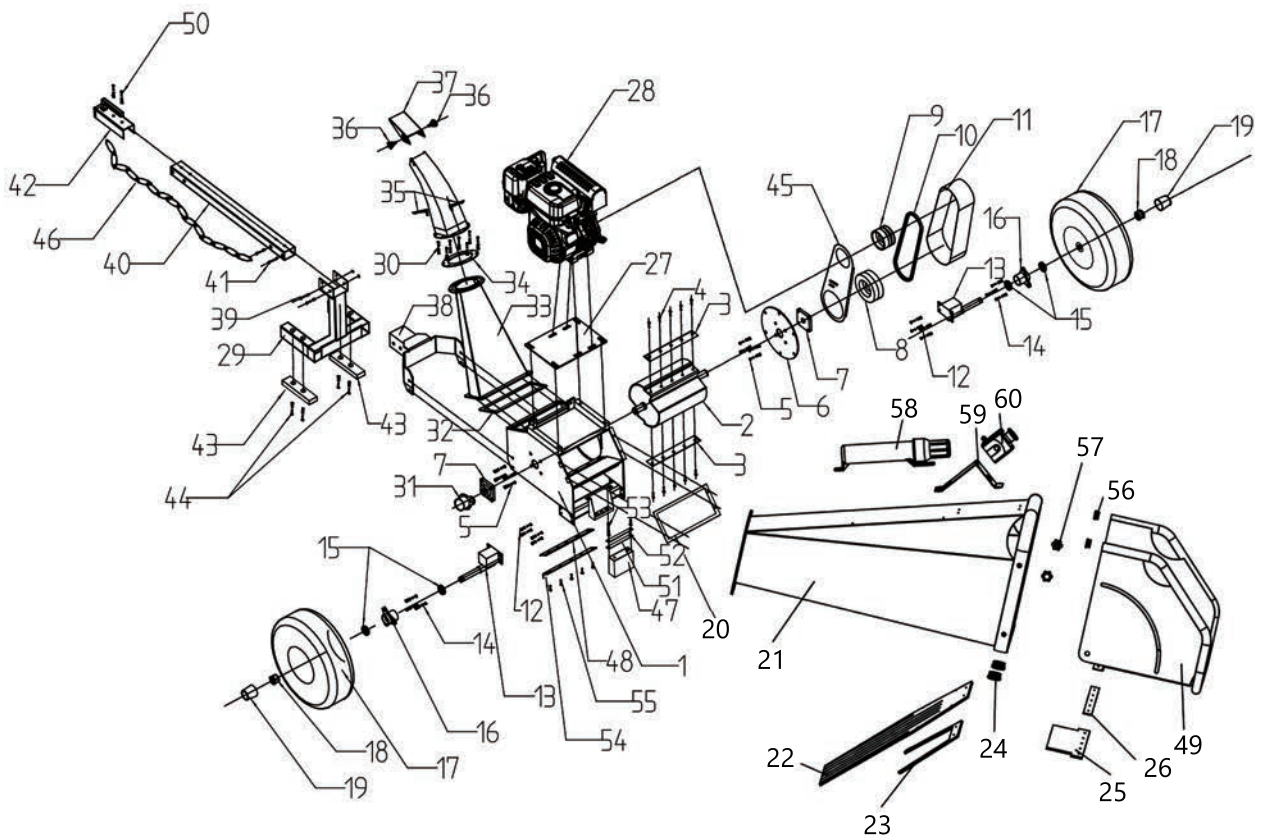

MAINTENANCE & STORAGE

PARTS LIST (GS150002)

NO.	DESCRIPTION	QTY.	NO.	DESCRIPTION	QTY.
1	Base frame	1	31	Bearing cover	1
2	Roller	1	32	Discharge to frame rubber	1
3	Knife	2	33	Discharge chute	1
4	M10x25 hex bolt	8	34	Flange to discharge chute	1
5	M12x40 hex bolt	12	35	M8x15 handle bolt	2
6	Bearing mounting plate	1	36	M8x15 bolt	2
7	Bearing	2	37	Chute deflector	1
8	Pulley	1	38	Feet fixation	1
9	Clutch	1	39	M10x70 hex bolt	2
10	Kevlar belt	2	40	Tow bar	1
11	Belt cover	1	41	M10x60 hex bolt	2
12	M10x25 hex bolt	8	42	2" coupler	1
13	Wheel axle	1	43	Rubber pad	2
14	M8x25 hex bolt	6	44	M8x30 hex bolt	4
15	Wheel bearing	2	45	Belt inner plate	1
16	Wheel flange	2	46	Safety chains	1
17	16*8.00-7 tire	2	47	Battery	1
18	M24x1.5 castle nut	2	48	Anvil	1
19	Wheel rubber cap	2	49	Feeding chute B	1
20	In-feed to frame rubber	1	50	M12x80 hex bolt	4
21	Feeding chute A	1	51	Rubber pad	1
22	Rubber chip baffle	1	52	Battery cover	1
23	Rubber baffle mount	1	53	M8x20 hex bolt	4
24	Tube plug Ø38	2	54	Anvil mounting plate	1
25	Rubber flap	1	55	M10x25 hex bolt	10
26	Rubber flap clamp	1	56	Tube plug Ø25	2
27	Engine base plate	1	57	Star nut M8	2
28	Engine	1	58	Manual holder	1
29	Support feet	1	59	Switch support	1
30	M6x25 hex bolt	8	60	Emergency stop button	1

